

GSL90RDS

90cm Slide-out Rangehood | Stainless

TECHNIKA®



Features

Finish	Stainless Fascia / White Housing
Fascia Size	40 / 80mm, Included (80mm Fascia Fitted)
Extraction Rate	440m ³ /h
Interface	3 speed slide control
Lighting Type	1x LED Strip
Filter Type	2x Aluminium Mesh
Operating Type	Ducted or Recirculating
Ducted Option	120mm Top Outlet
Recirculating Option	Front Vent Behind Fascia

Accessories Included

Charcoal Filter	1x Set of CF110
Ducting	1x 3m Length 120mm Flexi Ducting
Mounting Template	Yes



Scan for more info

GSL90RDS

90cm Slide-out Rangehood | Stainless

TECHNIKA®

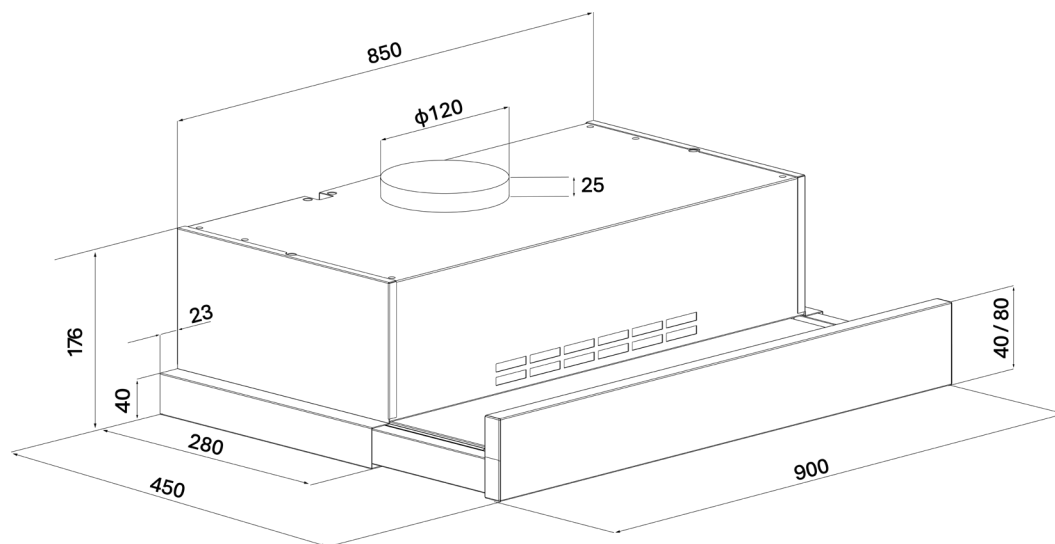

Installation

Electrical Connection	220 - 240V / 50Hz
LED Wattage	1x 5W
Motor Wattage	200W
Total Wattage	205W
Noise Level*	56 dB(A)
Ducting Diameter	120mm

Dimensions (W x H x D)

Boxed	1100 x 355 x 225mm
Product	900 x 176 x 300 - 450mm
Cabinet Required	900mm

Weight

Gross (Kg)	12.0
Net (Kg)	10.5

*Reading taken at top speed as per standard EN-IEC61591:1997/A2:2011

VERSION NO. 20241108

We reserve the right to make changes to products when considered necessary and useful, without affecting the essential safety and operating characteristics. We are constantly seeking ways to improve specifications and designs of our products. Whilst every effort is made to produce up to date literature, this document should not be regarded as infallible guide. Actual product only should be used to device cut out sizes.

technika.com.au