

TGU70S

70CM UNDERMOUNT RANGEHOOD

TECHNIKA

PROFESSIONAL SERIES

Features

3 fan speeds

700m³/h maximum airflow

Ducted operation

Stainless steel finish

Push button controls

1 durable aluminium / stainless steel honeycomb filters

2 2W LED lights

2 year warranty



TGU70S

70CM UNDERMOUNT RANGEHOOD

TECHNIKA

PROFESSIONAL SERIES

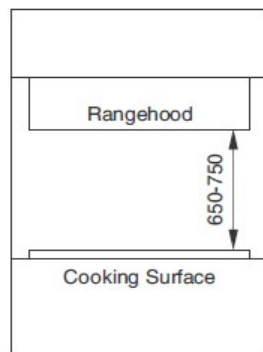

Recommended Clearances

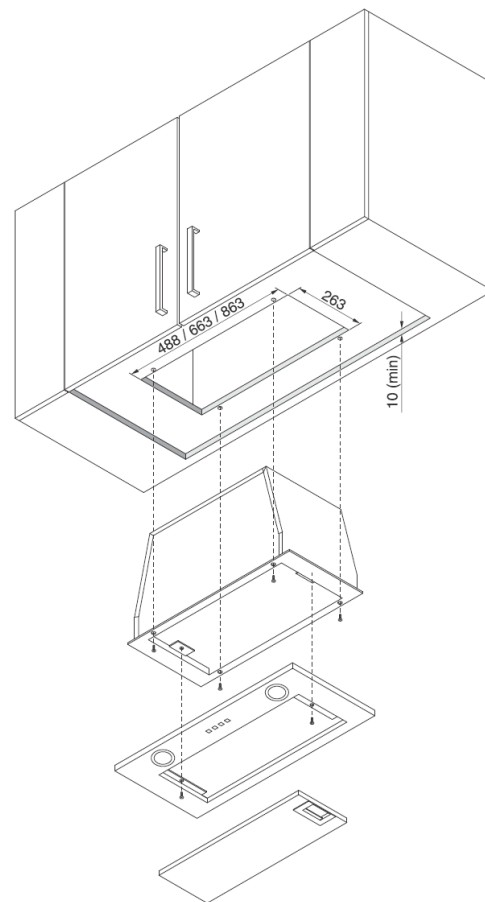
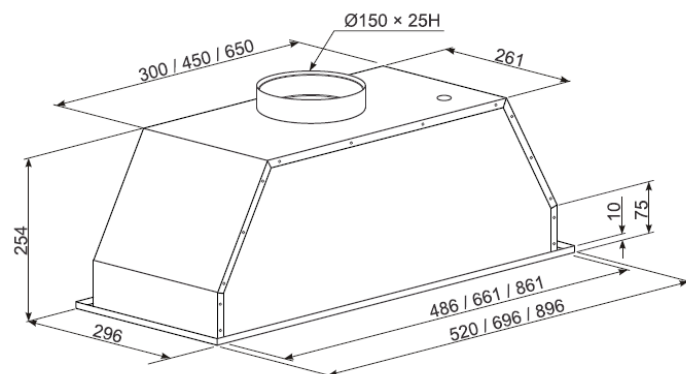

TGU70S	
Type	Undermount
Extraction	Ducted
RANGEHOOD FUNCTIONS	
No. of fan speeds	3
Lights	2 2W LED
RANGEHOOD FEATURES	
Maximum airflow (m3/h)	700
Maximum noise level (dBA)	60
Controls	Push button
Filters	1 aluminium / stainless steel honeycomb
INSTALLATION	
Electrical connection	10A plug
Power	220 - 240V / 50Hz
Motor (W)	190
DIMENSIONS (W x H x D)	
Product (mm)	696 x 254 x 296
Cut out (mm)	663 x 254 x 263