

*Instructions for Use and Installation*  
**Freestanding Cookers:**

- GHE09TDSS-4

**TECHNIKA**



# Contents

## **For your safety**

Safety of children and the infirm . . . . .	3
Cleaning and maintenance . . . . .	3
During use . . . . .	4
Installation . . . . .	5
Service and spare parts . . . . .	6

## **Use and Care**

Description of the appliance . . . . .	7
Oven & Accessories . . . . .	8
Controls . . . . .	9
Instructions for use . . . . .	10
How to use your oven . . . . .	12
Positioning the oven trays & shelves . . . . .	13
Cooking modes . . . . .	14
6-button digital clock . . . . .	16
Practical cooking advice . . . . .	19
Cleaning & maintenance . . . . .	25
Disposal . . . . .	30

## **Installation**

Technical data . . . . .	31
Instructions for Installation . . . . .	32
Dimensions . . . . .	33
Combustible surfaces . . . . .	33
Anti-tilting chain . . . . .	34
Connection to the gas supply . . . . .	35
Electrical connection . . . . .	36
Replacing the power supply lead . . . . .	36
Before leaving . . . . .	36

## **Gas Conversion**

NG - U-LPG . . . . .	37
U-LPG - NG . . . . .	38



## For Your Safety

We recommend that you read the instructions in this owner's manual carefully before use for the best performance and to extend the life of your appliance. It will provide you with all the information you need to ensure its safe installation, use and maintenance. Retain this owner's manual for future reference.

To maintain the efficiency and safety of this appliance, we recommend that you do the following:

- Always call the Technika service department if there are any faults with your appliance.
- Always use original spare parts available from Technika.
- This appliance is designed for non-commercial, household use and it must not be altered in any way.
- **This appliance can only be used safely when it is correctly connected to an efficient earthing system in compliance with current electrical safety standards.**
- **If the supply cord is damaged, it must be replaced by the manufacturer or its service agent or a similarly qualified person in order to avoid a hazard.**

Packaging items such as plastic bags, polystyrene, nails, etc. are potentially dangerous, and therefore appropriate measures must be taken to prevent children and the disabled from coming into contact with them.

### **Safety of children and the infirm**

This appliance must only be used by adults. Make sure that children do not touch the controls or play with the appliance.

The exposed parts of this appliance heat up during cooking and remain hot for some time even after it is switched off. Keep children well away until the appliance has cooled down.

### **Cleaning and maintenance**

Keep the appliance thoroughly cleaned. Food residues may cause fire risks.



## For Your Safety

### During use

- The appliance becomes hot. Care should be taken to avoid touching heating elements inside the oven.
- **WARNING: Accessible parts will become hot when in use. To avoid burns and scalds, children should be kept away.**
- The appliance is not intended for use by young children or infirm persons without supervision. Young children should be supervised to ensure that they do not play with the appliance.
- **DO NOT use a steam cleaner to clean the appliance.**
- This product is designed to cook foods inside private homes and for non-commercial purposes. It should not be used for any other purpose.
- After using the appliance, make sure that all controls are in 'CLOSED' or 'OFF' position.
- **DO NOT USE OR STORE FLAMMABLE MATERIALS IN THE APPLIANCE STORAGE DRAWER OR NEAR THIS APPLIANCE.**
- **DO NOT SPRAY AEROSOLS IN THE VICINITY OF THIS APPLIANCE WHILE IT IS IN OPERATION.**
- **DO NOT STORE OR USE FLAMMABLE LIQUIDS OR ITEMS IN THE VICINITY OF THIS APPLIANCE.**
- **WHERE THIS APPLIANCE IS INSTALLED IN MARINE CRAFT OR IN CARAVANS, IT SHALL NOT BE USED AS A SPACE HEATER.**
- Only use the appliance to cook food and nothing else.
- Disconnect the appliance from the electrical mains if it is not functioning properly and before cleaning or performing maintenance.
- Use oven gloves to place cookware in the oven or when removing it. Always grip the oven door handle in the centre.
- Technika will not accept any liability as a result of any damage due to incorrect installation or improper use.



## **For Your Safety**

### **Installation**

- **Installation of the appliance and its connection to the electrical mains must only be carried out by Authorised Personnel. Before any service procedure, it is important to check that the appliance is DISCONNECTED from the electrical mains.**
- **DO NOT MODIFY THIS APPLIANCE.**
- **After removing the appliance from the packaging, make sure that it is undamaged and that the electrical lead is in perfect condition. Otherwise, contact your dealer before operating the appliance.**
- **Make sure that air is able to circulate freely around the appliance. Poor ventilation produces a shortage of oxygen.**
- **Make sure that the appliance is supplied with the type of gas indicated on the data label and the gas type label next to the gas connection point.**
- **Use of a gas cooking appliance produces heat and moisture in the room in which it is installed. Ensure that the room is well ventilated by keeping the air intakes open and in good working order or by installing an extractor hood with discharge pipe.**
- **If the appliance is used intensively for a long time the effectiveness of the ventilation will have to be increased, for example by opening a window or increasing the power of any electric extractor fan.**
- **NOT FOR USE IN MARINE CRAFT, CARAVANS OR MOBILE HOMES UNLESS EACH BURNER IS FITTED WITH FLAME SAFEGUARD.**



## For Your Safety

### **Avoid the following:**

- Touching the appliance with wet parts of the body.
- Using the appliance while barefoot.
- Improper or dangerous operation.
- Obstructing the ventilation or heat dissipation slots.
- Allowing power supply cables of other appliances to come into contact with hot parts of the oven.
- Exposing the appliance to atmospheric agents such as rain, or direct sunlight.
- Using the oven for storage purposes.
- Using flammable liquids near the appliance.

### **Authorised personnel must be contracted to...**

- Install the appliance according to these installation instructions and any local requirements.
- Replace the temperature probe if it is damaged. The probe is part of thermostat. Only use the temperature sensing probe recommended for this oven.

### **Technika Service Department must be contacted...**

- If in doubt about the operation of the appliance.
- If in doubt about the soundness of the appliance after removing it from its packaging.
- If the power supply cable has been damaged or needs to be replaced.
- If the appliance requires a service or you need spare parts.

### **Service and spare parts**

If the appliance fails to operate correctly, never attempt to repair the appliance yourself. Repairs by unskilled persons may cause damage and accidents. First refer to the contents of this manual. If you do not find the necessary information, contact your nearest Service Center. Servicing work on this appliance must be carried out by Authorised Personnel. Always request the use of original spare parts.

**For Service & Spare Parts please contact: 1800 333 244**



## Use and Care

### Description of the appliance

1. Timer
2. Control Knob (Cooktop Burners)
3. Cooking Temperature Selection Knob
4. Cooking Mode Selection Knob
5. Auxiliary burner
6. Semi-Rapid burner
7. Wok burner
8. Rapid burner
9. Pan supports





## Use and Care

### Oven & accessories

The oven is supplied with chrome wire Shelf Supports and a range of shelf options as shown below. There are four shelf positions on the oven.







# Use and Care

## Controls

Digital Automatic Clock

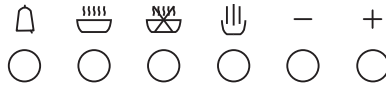

- Timer
- Cook time
- Finish time
- Manual operation
- Decrease time
- + Increase time

Control Knob  
(Cooktop Burners)

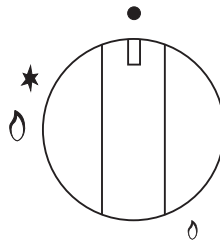

Cooking Temperature  
Selection Knob

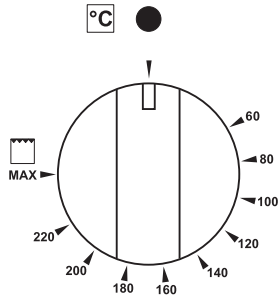

Cooking Mode  
Selection Knob

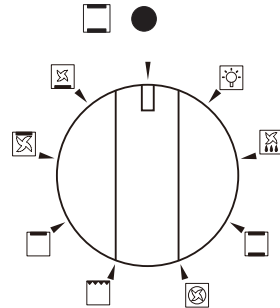



## Use and Care

### Instructions for use (cooktop burners)

The symbols on the control knobs mean the following:

● No gas flow or 'Off'

★  
🔥 Maximum gas flow or 'high' flame and lighting position

◊ Minimum gas flow or 'low' flame

All operating positions must be set between the maximum and minimum flow settings, and never between the maximum setting and the closed position.

A - Burner cap

B - Burner Head

C - Burner Bowl

D - Thermocouple (where fitted)

E - Electrode

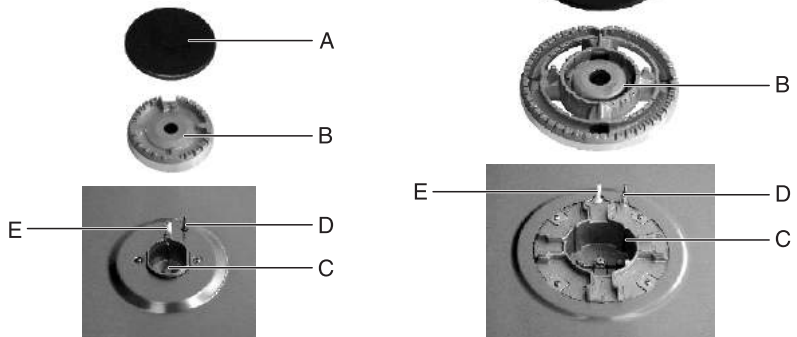

Fig. 1



## Use and Care

### To light the cooktop burners

To light the burner, press the control knob fully down and hold the knob down before rotating anti-clockwise to the High Flame position. The ignition device is integrated into the control knob and is automatically activated by pushing down on the control knob.

After lighting the flame, keep the knob pressed for about 10 seconds: this time is necessary to heat up the thermocouple (Fig.1-D) and activate the safety valve, which would otherwise cut off the gas flow. This step only applies where flame failure device is fitted.

In the instance of a power failure, place a lit match near the burner and proceed as described above. If the flame does not light after the first attempt, wait 5 minutes for the gas to dissipate before attempting to re-light the burner.

Once lit, check that the flame is even and turn the control knob to adjust the flame as required. If the flame is uneven, check that the 'burner head/skirt' and 'burner cap' are correctly positioned. To turn off the flame, turn the control knob clockwise to the off position (● symbol). Before removing pots or pans from the burners, always turn off the flame.

### For correct use of the cooktop

For lower gas consumption and better efficiency, use only flat-bottomed pans of dimensions suitable for the burners, as shown in the table below. Also, as soon as a liquid comes to the boil take care to turn the flame down to a level that will just keep it boiling.

<u>Burner</u>	<u>Minimum diameter</u>	<u>Maximum diameter</u>
Large(rapid)	150mm	260mm
Medium(semi-rapid)	130mm	180mm
Small(Auxiliary)	90mm	160mm
Triple Flame (Wok)	210mm	270mm

The use of pans in excess of the maximum diameter recommended in the table above can result in over heating/disco-  
loration of hob surface.

During cooking processes involving fats or oils, watch your foods carefully because these substances may catch fire if overheated.



## Use and Care

### How to use your oven

This multi-function oven combines the advantages of traditional convection ovens with modern fan assisted ovens in a single appliance. It is an extremely versatile appliance that allows you to choose easily and safely between different cooking modes. The various cooking modes are selected by means of a cooking mode selection knob, located on the control panel.

To operate the oven:

- Ensure that manual mode is selected (page 16)
- Turn the cooking mode selection knob to the desired cooking mode (explanation of cooking modes is on pages 14 to 15)
- Turn the cooking temperature selection knob to the desired temperature (cooking guide is on pages 23 to 24) or to 'MAX' if Grilling.

The first time you use your appliance, we recommend that you set the thermostat to the highest setting, set the cooking mode selection knob to a cooking mode and leave the oven on for about half an hour with nothing in it and the oven door closed. Then, open the oven door and allow the oven to cool. Any odour that may be detected during this initial use is due to the evaporation of substances used to protect the oven during storage.

**Note:** Place the Baking Tray provided on the bottom shelf position of the oven to prevent any spillages from dripping onto the bottom of the oven. **Never place anything (including foil and oven trays) on the bottom of the oven when it is in operation because this could damage the enamel.** Only place your cookware (dishes, trays, aluminum foil, etc.) on the Oven Shelves provided with the appliance.



If supplied, use the chrome wire handle shown left when removing the trays from the oven.



## Use and Care

### Positioning the oven trays & shelves

The Baking Tray, Grill Tray or Oven Shelf can be located in any of the five height positions in the oven if your oven does not have Telescopic Shelf Supports. Oven Shelves **cannot** be fitted to the Telescopic Support. **Only fit the Baking Tray or Grill Tray to the Telescopic Support.**

Refer to the 'Cooking Mode Table' for the recommended shelf position. When fitting the trays or shelves, ensure they are fitted between the two wires that are closest together as shown below. Oven Shelves have a stop so that they are not fully withdrawn by accident. To fully remove the Oven Shelves, lift the front of the shelf slightly and withdraw fully from the oven. Note that the Grill Tray and Baking Tray do not have a stop position and can be fully withdrawn without interruption, so be careful not to accidentally fully withdraw the trays.

Fit Trays and Shelves between bars as shown right

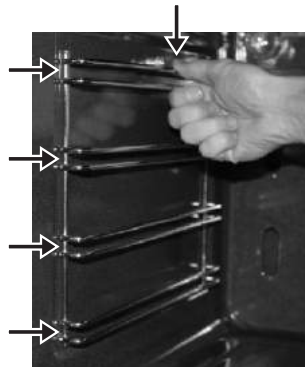

To remove the Oven Shelf Support, push down on the wire below the locking pin, pull away from the oven wall until you can release the bottom of the support from the holes in the oven wall. Replace in reverse procedure.



Oven Shelf fitted to chrome wire Shelf Support



## Use and Care

### COOKING MODES

#### Defrost mode

When set to 'Defrost' mode, the fan located at the back of the oven circulates room temperature air around the food. This is recommended for the defrosting of all types of food, but in particular for delicate types of food which do not require heat, for example: ice cream cakes, cream or custard desserts, fruit cakes, etc. By using 'Defrost' mode, the defrosting time is approximately halved. In the case of meat, fish and bread, it is possible to accelerate the process by selecting 'Multi Cooking mode' and setting the temperature between 80°C to 100°C.

#### Convection mode

When set to Convection mode, the top and bottom heating elements operate together like a 'normal' conventional oven that you have probably used before.

Convection mode is best suited for traditional baking and roasting and you should only use one shelf at a time, otherwise the heat distribution will be uneven. You can balance the amount of heat between the top and the bottom of the dish by selecting a different shelf height. If you want more heat at the top of the dish place the dish on the top or second shelf. For more heat at the bottom of the dish, place the dish on third or fourth shelf.

#### Baking mode

When set to Baking mode, the fan element and the fan operate providing a delicate heat distributed uniformly throughout the oven.

This mode is ideal for baking and cooking delicate foods on multiple shelves, especially cakes that need to rise such as cream puffs and for certain tartlets, sweet or savoury biscuits, savoury puffs, swiss rolls and small portions of vegetables, etc.



## Use and Care

### Grill mode

Select 'Grill' mode with cooking mode selection knob and turn cooking temperature selection knob to '**Max**'. When set to Grill mode, the top inner element operates. The extremely high and direct temperature of the grill makes it possible to brown the surface of meats and roasts while locking the juices in to keep them tender. Grill mode can also be used for dishes that require a high temperature on the surface such as beef steaks, veal, rib steak, filets, hamburgers, etc.

Grill food with the oven door closed.

### Top heat mode

When set to Top heat mode, the top heating element operates. This mode can be used to brown food at the end of cooking.

### Fan assisted Top heat mode

Select 'Fan Assisted Top' mode with cooking mode selection knob and turn cooking temperature selection knob to the desired temperature setting. When set to Fan Assisted Top mode, the top inner element and the fan operate. This mode increases the circulation of air throughout the oven, which helps prevent food from burning on the surface, allowing the heat to penetrate right into the food. Particularly suitable for kebabs made with meats and vegetables, sausages, ribs, lamb chops, chicken, quail, pork chops, fish steaks, stuffed cuttlefish etc.

### Delicate cooking mode

When set to Delicate cooking mode, the bottom element and the fan will operate. This mode is suitable for pastries, cakes and no dry sweets in baking tins or moulds that require heat from the bottom.



## Use and Care

### 6 BUTTON DIGITAL CLOCK

This model has a digital display, 24hr clock with 6 control buttons. When the power is connected, the screen displays 3 flashing numbers and 'AUTO'.

#### Adjusting the digital clock



To set the correct time, press the  button first, then + or - button to advance forward or backward until the correct time is displayed.

#### Manual operation setting

If 'AUTO' is flashing, automatic or semi-automatic program has been set. Press  button, 'AUTO' will clear from the display and the oven can be operated manually.



#### Automatic setting

Automatic setting of the oven allows you to select the end time, cooking time, temperature and cooking mode. The oven will switch on, cook according to the selected cooking mode and temperature and then switch off automatically.

1. Press  button, set cooking time with + and - buttons.
2. Press  button, set roast finish time with + and - buttons.
3. Set cooking temperature and cooking mode by turning the thermostat knob and selector knob.

After the above setting, 'AUTO' will illuminate, which means the automatic cooking feature of the oven is set.

**For example:** if cooking time takes 45 minutes and you want it to finish at 14:00:

1. Press  and set the cook time to 45 minutes using + and - buttons.
2. Press  and set the finish time to 14:00 using + and - buttons.

After the above setting, the current time is displayed and 'AUTO' will flash, indicating that the automatic cooking feature is set. When the clock displays 13:15, the oven will start cooking automatically. While cooking, 'AUTO' and  will flash.

When the clock displays 14:00, the oven automatically stops cooking. The alarm will ring and 'AUTO' will flash, press the  button and the ringing will stop.





## Use and Care



### Semi-automatic setting

There are two methods of semi-automatic cooking:

#### A. Start cooking now and set cooking time:



This semi-automatic setting of the oven allows you to start cooking immediately, set the cooking time (up to 10 hours), select the temperature and cooking mode. The oven will cook according to the selected cooking mode and temperature and then switch off automatically once the cooking time has elapsed.



1. Press  button, set cooking time with + and - buttons.
2. Set cooking temperature and cooking mode by turning the thermostat knob and selector knob.

The oven starts immediately,  and 'AUTO' will flash. After the cooking time has elapsed, the oven automatically stops cooking. The alarm will ring and 'AUTO' will flash, press the  button and the ringing will stop.

#### B. Start cooking now and set the finish time:

1. Press  button, set cooking finish time with + and - buttons (up to 23 hours and 59 minutes).
2. Set cooking temperature and cooking mode by turning the thermostat knob and selector knob.

The oven starts immediately,  and 'AUTO' will flash. When the finish time is reached, the oven automatically stops cooking. The alarm will ring and 'AUTO' will flash, press the  button and the ringing will stop.







When the  button is pressed during semi-automatic cooking, the set cooking time is displayed. If the  button is pressed and the time is set back to '0', the semi-automatic setting will be cancelled. When  button is pressed again, the oven will revert to the manual mode.



## Use and Care

### Timer

The digital countdown timer can be set up to 23 hours and 59 minutes maximum.

To set the timer, press the  button and then + or - button until the desired time is displayed. Once the  button is released, the current time and  is displayed. When the  button is pressed the remaining time is displayed. When the set time is reached,  disappears and the alarm will ring. To stop the alarm, press the  button.

**Note:** After pressing the  button, timer settings should be done within 5 seconds.

In case of a power failure, all settings including the time display will be lost. When the power is returned, three '0' and 'AUTO' will be displayed.

### The oven light

Set cooking mode selection knob to  symbol to switch on the oven light/s. The oven light/s stay on when the oven is operating.

### Cooling ventilation

In order to cool down the exterior of the appliance, this model is equipped with a cooling fan, which switches on automatically. When the cooling fan is on, you will notice a flow of air exiting between the oven door and the control panel.

**Note:** When cooking is finished, the cooling fan continues to operate until the oven cools down and then switches off automatically.





## Use and Care

### PRACTICAL COOKING ADVICE

The oven offers a wide range of settings which allow you to cook any type of food in the best possible way. With time you will learn to make the best use of this versatile cooking appliance and the following directions are only a guideline which may be varied according to your own personal experience.

#### Preheating

If the oven needs to be preheated, the 'Convection' mode  or 'Baking' mode  should be selected. These are the most efficient modes, which will reach the desired temperature as quickly as possible using the least amount of energy.

Once the food has been placed in the oven, the desired cooking mode should then be selected.

#### Multi shelf cooking

If you want to cook food on several shelves, select the 'Baking' mode  as this is the only cooking mode that allows you to do so.

When cooking delicate foods on more than one shelf, use the 'Baking' mode. This mode allows you to cook on 3 shelves at the same time. Refer to the 'Cooking Guide' table.



## Use and Care

### Using the grill

This multi-function oven has 2 different grilling modes.

Use the 'Grill' mode  with the oven door **closed**, place the food on the centre of the grill pan, insert and fit the grill pan on either the 3rd or 4th shelf from the bottom. Note: only the central part of the top heating element operates for grilling.

When using 'Grill' mode, we recommend you set the thermostat to the highest setting. However, this does not mean you cannot use lower temperatures, simply adjust the thermostat knob to the desired temperature.

Use 'Fan assisted grill' mode  with the oven door **closed**. This mode is very useful for grilling foods rapidly, as the distribution of heat by the fan makes it possible not only to brown the surface, but also to cook the bottom of the food. It can also be used for browning foods at the end of the cooking process, such as adding that gratin finish to pasta bakes for example.

When using 'Fan assisted grill' mode, place the food on the 2nd or 3rd oven shelf from the bottom, then place a dripping-pan on the 1st rack from the bottom to prevent fat and grease from dripping onto the oven floor. We recommend you set the thermostat to 200°C, as it is the most efficient temperature for 'Fan assisted grill' mode. However, this does not mean you cannot use lower temperatures, simply adjust the thermostat knob to the desired temperature.

**Important:** for best results and to save energy, always use the 'Fan assisted grill' with the oven door **closed**.



## Use and Care

### **Baking cakes**

When baking cakes, always place them in a preheated oven. Make sure you wait until the oven has been preheated thoroughly (the indicator light will turn off). To prevent heat loss and the cake from dropping, do not open the oven door during baking.

In general...

#### **... if pastry is too dry**

Increase the temperature by 10°C and reduce the cooking time.

#### **... if pastry has dropped**

Use less liquid or lower the temperature by 10°C.

#### **... if pastry is too dark on top**

Place it on a lower shelf, lower the temperature, and increase the cooking time.

#### **... if cooked well on the inside but sticky on the outside**

Use less liquid, lower the temperature, and increase the cooking time.

#### **... if the pastry sticks to the pan**

Grease the pan well and sprinkle it with a dusting of flour or use greaseproof paper.

#### **... if I used multi shelf cooking and one shelf is more cooked**

Use a lower temperature setting next time. It is not necessary to remove the food from all the racks at the same time.



## Use and Care

### **Cooking pizza**

For best results when cooking pizza:

- Preheat the oven for at least 10 minutes.
- Use a light aluminum pizza pan, placing it on the shelf supplied with the oven. Don't use the dripping pan since this will extend the cooking time, making it difficult to get a crispy crust.
- Do not open the oven door frequently while the pizza is cooking;
- If the pizza has a lot of toppings (three or four), we recommend you add the mozzarella cheese on top halfway through the cooking process.
- For best results, only use one shelf at a time, but if you want to cook on two shelves, use the 2nd and 4th racks from the bottom with a temperature of 220°C and swap them halfway through cooking.

### **Cooking fish and meat**

When cooking white meat, fowl and fish, use a temperature setting from 180°C to 200°C.

For red meat that you want well done on the outside while tender and juicy in the inside, it is best to start with a high temperature setting (200°C-220°C) for a short time, then turn the oven down afterwards.



In general, the larger the roast, the lower the temperature setting. Place the meat on the centre of the shelf and place the dripping pan beneath it to catch the fat.

Make sure that the shelf is inserted so that it is in the centre of the oven. If you would like to increase the amount of heat from below, use a lower shelf height. For savoury roasts (especially duck and wild game), dress the meat with lard or bacon on the top.



# Use and Care

## Cooking guide

Selector knob setting	Food to be cooked	Level from below	Temperature (°C)	Time in minutes(*)
<b>Traditional cooking</b>  	<b>First courses</b>			
	Lasagne	2-3	210-230	30
	oven-baked pasta	2-3	210-230	40
	<b>MEAT</b>			
	Roast veal	2	175-200	30-40/kg
	Roast beef	2	210-240	30-40/kg
	Roast pork	2	170-200	30-40/kg
	Chicken	2	170-200	45-60
	Duck	2	170-200	45-60
	Goose-turkey	2	140-170	45-60
	Rabbit	2	170-200	50-60
	Leg of lamb	1	170-200	15/kg
<b>Roast fish</b>	1-2	170-200	According to dimensions	
<b>Pizza</b>	1-2	210-240	40-45	
<b>DESSERTS</b>				
Meringue	1-2	50-70	60-90	
Short pastry	1-2	170-200	15-20	
Ciambella	1-2	165	35-40	
Savoyards	1-2	150	30-50	
Brioches	1-2	170-200	40-45	
Fruit cake	1-2	170-200	20-30	
	Browning food to perfect cooking	3-4	15	220



(\*) With preheated oven

Selector knob setting	Food to be cooked	Level from below	Temperature (°C)	Time in minutes
<b>Fan forced cooking</b>  	<b>First courses</b>			
	Lasagne	2	190-210	20-25
	Oven-baked pasta	2	190-210	25-30
	Creole rice	2	190-220	20-25
	<b>MEAT</b>			
	Roast veal	2	150-170	65-90
	Roast pork	2	150-160	70-100
	Roasted beef	2	160-170	65-90
	Fillet of beef	2	160-180	35-45
	Fillet lamb	2	130-150	100-130
	Roast beef	2	170-180	40-45
	Roast chicken	2	170	70-90
	Roast duck	2	160-170	100-160
	Roast turkey	2	150-160	160-240
	Roast rabbit	2	150-160	80-100
	Roast hare	2	160-170	30-50
	Roast pigeon	2	140-170	15-25
	<b>Fish</b>	2-3	150-170	According to dimensions
	<b>Pizza</b>	2-3	210-240	30-50
	<b>DESSERTS (PASTRIES)</b>			
	Ciambella	2-3	150-170	35-45
	Fruit cake	2-3	170-190	40-50
	Sponge-cake	2-3	190-220	25-35
Brioches	2-3	160-170	40-60	
Strudel	1-2	150	25-35	
Savoyard pudding	2-3	160-170	30-40	
Bread	2-3	190-210	40	
Toast	1-2	220-240	7	



## Use and Care

### Cooking guide (cont'd)

Selector knob setting	Food to be cooked	Level from below	Time in minutes	
			First surface	Second surface
<b>Grilling</b>  	Pork chops	4	7-9	5-7
	Fillet of pork	3	9-11	5-9
	Fillet of beef	3	9-11	9-11
	Liver	4	2-3	2-3
	Veal Escalopes	4	7-9	5-7
	Half chicken	3	9-14	9-11
	Sausages	4	7-9	5-6
	Meat-balls	4	7-9	5-6
	Fish fillets	4	5-6	3-4
	Toast	4	2-4	2-3

**Note:** Cooking times are approximate and may vary according to personal taste. When cooking using the grill or fan assisted grill, the dripping pan must always be placed on the 1st oven shelf from the bottom.





## Use and Care

### **Cooktop cleaning and maintenance**

Before cleaning, make sure all burners are 'off' and allow the appliance to cool down.

The enamelled or stainless steel parts should be washed with lukewarm water without using any abrasive powders or corrosive substances. Spray on surface cleaners should also be avoided.

The use of these cleaners can result in the development of rust and corrosion.

If any stainless steel has difficult to remove stains, use cleaners specifically recommended to clean stainless steel. After cleaning any surface, it is advisable to rinse thoroughly and dry.

Wash the burner caps and head/skirts often with hot water and detergent, taking care to remove all deposits. Ensure the burner ports in the head/skirts are clear and are not blocked by water or detergent. The hob pan stands can also be washed in a dishwasher. For stubborn dirt, use ordinary non-abrasive detergents or specific commercial products. We strongly advise not to use scouring pads, steel wool or acids for cleaning. Do not steam clean this appliance.

### **Ignition plug**

Automatic burner ignition is provided by a ceramic 'plug' and a metal electrode (E in fig.1). Periodically clean these parts of the hob thoroughly. In addition, to avoid ignition difficulties, check that the cavities in the burner are not obstructed. To remove deposits from the burner cavities, remove the burner caps (see images right). After cleaning, put the burner heads and caps back together and return them correctly to their position. After washing, replace the pan supports, checking that they are correctly positioned.



## Use and Care

### Oven cleaning and maintenance

Before cleaning your oven or performing maintenance, make sure that the cooking mode selection knob and the cooking temperature selection knob is set to 'OFF'. To extend the life of your oven, it must be cleaned frequently.

The inside of the oven should preferably be cleaned immediately after use, when it is still warm (but not hot), with warm water and soap. The soap should be rinsed away and the interior dried thoroughly. Avoid using abrasive detergents, scourers acidic cleaners such as lime scale remover, etc. as these could damage the enamel, and can result in the development of rust and corrosion. If stains are particularly tough to remove, use cleaners specifically recommended to clean ovens and follow the instructions provided with the cleaner. **Never use a steam cleaner for cleaning inside the oven.**

If you operate your oven for an extended period of time, or if you are cooking dishes that contain a lot of water, condensation may form on the oven door. Dry it using a soft cloth and try reducing the cooking temperature.

There is a rubber seal surrounding the oven opening which is necessary to ensure the correct operation of the oven. Check the condition of this seal on a regular basis. If necessary, clean it but avoid using abrasive products or objects to do so. Should it become damaged, please contact Technika Service Department. We recommend you avoid using the oven until it has been repaired.

**Never place anything (including foil and oven trays) on the bottom of the oven when it is in operation because this could damage the enamel.**

Clean the glass door using non-abrasive products or sponges and dry it with a soft cloth.

Do not use abrasive cleaners or sharp metal scrapers to clean the oven door glass since they can scratch the surface, which may result in shattering the glass.



## Use and Care

### How to remove the oven door

You can remove the oven door for better access to the oven when cleaning. There are 2 styles of oven door so you should first identify which style you have. Proceed as follows for each style:

#### Oven door style 1:

##### Remove and assemble procedure

- Open door fully
- Lift up and turn the small levers situated on the two hinges fully back
- Grip the door on the two external sides; shut it slowly until door contacts the clips. Then continue closing door until it is about 10cm from closing fully.
- Pull the door towards you, pulling it out of its seat. Door will gently come away from oven.
- To reassemble the door follow the above procedures backwards.

Please note if door does not come away from oven easily do not force fully remove.

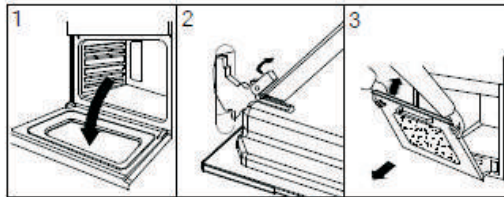

#### Oven door style 2:

- Open the door fully.
- Lift up and turn the small hooks situated on the two hinges.
- Grip the door on the two external sides and close it approximately half way. Unlock the door by pressing on the clamps 'A'.
- Pull the door up towards you, lifting it out of the oven frame.
- To replace the door, use the reverse procedure.

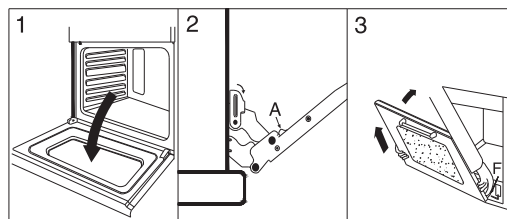



## Use and Care

### Replacing the oven lamps

**WARNING: Ensure that the appliance is switched off before replacing the lamp to avoid the possibility of electric shock.**

Remove the glass cover of the lamp-holder as shown below.

Remove the lamp and replace with a lamp resistant to high temperatures (300°C) with the following characteristics:

- Voltage: 220-240V
- Wattage: 25W
- Type: E 14

Replacement lamps are available from Technika. Replace the glass cover and reconnect the oven to the mains power supply.

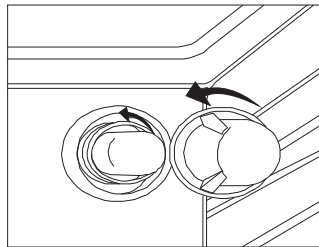



## Use and Care

### **Routine maintenance**

Have the condition and efficiency of the gas pipe and the pressure regulator (if installed) checked periodically. If anomalies are found, do not repair components but have the faulty component replaced. To ensure good performance and safety, the gas regulator taps must be greased periodically.



Periodic lubrication of the taps and any other appliance service must only be carried out by Authorised Personnel.

### **Abnormal operation**

Any of the following are considered to be abnormal operation and may require servicing:

- Yellow tipping of the burner flame.
- Sooting up of cooking utensils.
- Burners not igniting properly.
- Burners failing to remain alight.
- Burners extinguished by cupboard doors.
- Gas valves, which are difficult to turn.

In case the appliance fails to operate correctly, contact Technika.

### **Service and parts**

Before leaving the factory, this appliance was tested and adjusted by specialist skilled staff to give the best operating results. Any subsequent necessary repairs or adjustments must be carried out with the greatest care and attention by authorised personnel. For this reason, we strongly advise you contact the Technika Service Center, specifying the nature of the problem, the model of the equipment and the serial number. This data is provided on the data label adhered to the base of the appliance and on the duplicate data label. Always use original Technika spare parts.

### **Warranty**

Your new appliance is covered by a warranty. The details of your warranty conditions are on your Warranty Card supplied with the appliance. Keep the physical receipt which documents your purchase of the appliance and purchase date as you will need to show this for any Warranty repairs. Warranty cannot be claimed without proof of purchase.



## Use and Care

### Disposal

By ensuring this product is disposed of correctly, you will help prevent potential negative consequences for the environment and human health, which could otherwise be caused by inappropriate waste handling of this product.



The symbol on the product indicates that this product may not be treated as household waste. Instead it shall be handed over to the applicable collection point for the recycling of electrical and electronic equipment.

Disposal must be carried out in accordance with local environmental regulations for waste disposal.

For more detailed information about treatment, recovery and recycling of this product, please contact your local city council office.



# Installation

## Technical data

- Gas intake connection 1/2" BSP
- Electricity supply 240V AC (50Hz)

Burner Type	Natural Gas 1.0 kPa		Universal LPG 2.75 kPa	
	Injector (mm)	Nominal Gas Consumption	Injector (mm)	Nominal Gas Consumption
Auxiliary	0.88	3.7 MJ/h	0.53	3.4 MJ/h
Semi Rapid	1.16	6.8 MJ/h	0.68	6.0 MJ/h
Rapid	1.50	11.0 MJ/h	0.88	10.2 MJ/h
Wok	1.75	14.5 MJ/h	1.00	13.1 MJ/h

Inner dimensions of the oven:

Width: 69 cm    Depth: 43 cm    Height: 37 cm

Inner Volume of the oven: 105 litres.

Voltage and Frequency of Power Supply:

240V ~ 50Hz

Electrical Features:

Oven light: 2×25W

Spit motor: 4W

Upper heating element: 900W

Bottom heating element: 1800W

Grill heating element: 2300W

Circular heating element: 2×1250W

Motor ventilator: 2×20W

Cooling fan: 18W



# Installation



## **Instructions for installation**

This appliance shall be installed only by authorised persons and in accordance with the manufacturer's installation instructions, local gas fitting regulations, municipal building codes, electrical wiring regulations, AS 5601-2004 - Gas Installations and any other statutory regulations.

### **IMPORTANT: Installation, assembly and gas/electrical connections must be carried out by authorised personnel.**

**Data Label** - The Data Label is located on the rear of the appliance. A duplicate Data Label is supplied to adhere in an accessible area next to the appliance. This appliance is suitable for Natural Gas and Universal LPG; ensure that the available gas supply matches the Data Label and the gas type label.

**Ventilation** - Ventilation must be in accordance with AS5601-2004 - Gas Installations. In general, the appliance should have adequate ventilation for complete combustion of gas, proper flueing and to maintain temperature of immediate surroundings within safe limits.

Before any procedure, it is important to check that the appliance is **DISCONNECTED** from the electrical mains. The Manufacturer declines all responsibility for any damage deriving from installations in breach of the regulations in force or from failure to comply with these installation instructions.





# Installation

## Dimensions

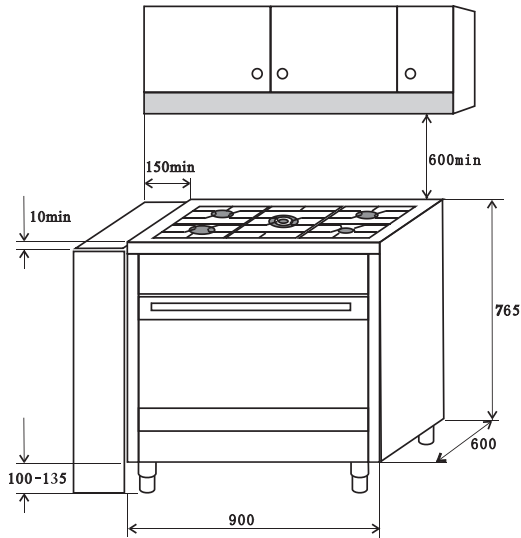

The Gas Inlet Connection is male ½" BSP and is located 55mm from the right and 560mm from the floor.

## Combustible Surfaces

This appliance shall be installed in accordance with AS 5601-2004 - Gas Installations Figure 5.1: Required Clearances around Domestic Cooking Appliances.

Any adjoining wall surface situated within 200mm from the edge of any burner must be a suitable non-combustible material for a height of 150mm for the entire length of the appliance. Any combustible construction above the appliance must be at least 600mm above the top of the burner and no construction shall be within 450mm above the top of the burner. Zero clearance is permitted on the side and rear adjoining surfaces below the maintop.

If the bench-top is situated within 200mm from the edge of any burner, it should be 10mm or more below the hob as shown above.

Install Range Hoods and Exhaust Fans in accordance with the manufacturer's instructions, no closer than 600mm above the maintop for Range Hoods and 750mm for Exhaust Fans.



# Installation

## **Freestanding or plinth installation**

The appliance can be installed as a freestanding cooker or it can be installed on a plinth. If installing the appliance as a freestanding cooker, screw the height adjustable telescopic legs supplied to the base of the appliance. If installing the appliance on a plinth, screw the levelling feet supplied to the base of the appliance.

## **Anti-tilting chain/hose restraining chain**

**WARNING: Ensure the chains are correctly anchored to prevent the appliance from tilting forward and to prevent strain on the hose when the cooker is pulled forward.**

**MAKE SURE THE CHAINS ARE TAUGHT WHEN ANCHORED TO PREVENT THE APPLIANCE TILTING.**

The cooker is supplied with two chains which are connected to the rear left and right of the appliance. The chains should be connected to the wall directly behind the chains as low as possible to prevent the appliance from tilting forward. If the appliance is installed between two cupboards, holes should be drilled on each side of the cupboards and the chains should be anchored within each side of the cupboards.

The chains also prevent strain on the hose when the cooker is pulled forward.

Ensure the chain connections are strong enough to support the weight of the appliance. Also ensure the chains are taught to prevent the appliance from tilting.

Once the chains are installed, check that they prevent the appliance from tilting forward and that there is no strain on the hose when the cooker is pulled as far forward as the chains allow.



# Installation

## Connection to the gas supply

For ease of service, the cooker should be connected with a Flexible Hose, which complies with AS/NZS 1869 (AGA Approved), 10mm ID, class B or D, between 1 - 1.2m long and in accordance with AS5601 for a high level connection.



**WARNING:** Ensure that the hose is not subjected to abrasion, kinking or permanent deformation and should be able to be inspected along its entire length. Unions compatible with the hose fittings must be used and connections tested for gas leaks. The fixed consumer piping outlet should be at approximately the same height as the cooker connection point, pointing downwards and approximately 200mm - 300mm in from the left hand side of the cooker. The hose should be clear of the floor when the cooker is in the installed position. The hose restraint chain supplied should be anchored to the wall so that the chain prevents strain on the hose connections when the cooker is pulled forward.

The supply connection point must be accessible with the appliance installed. Fit the supplied elbow and gasket as shown in the illustration below. The gas inlet connection has a 1/2" BSP male thread. When making the connection, take care not to apply excessive stress by counterbalancing tightening force. Ensure that the available gas supply is the same as the gas type label affixed near the gas connection point. If not, contact Technika for a Gas Conversion Kit. The gas supply pressure must be adjusted in accordance with the data label for the gas type. Adjust the test point pressure with the largest burner operating at maximum.

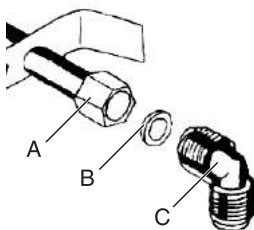

- A - Manifold Nut
- B - Gasket
- C - Elbow



# Installation

## **Electrical connection**

Fit a plug that is appropriately rated for the load indicated on the data plate to the cable supplied with the appliance. The plug must be compatible with the socket outlet fitted to the final sub-circuit in the fixed wiring that is intended to supply this appliance.

If connecting the cable directly to the mains, install a suitable isolating switch with a minimum contact opening of 3mm between the appliance and the mains. The isolating switch should be sized according to the load on the data label and should comply with current regulations (the earth wire should not be interrupted by the circuit breaker).

Connection to the electricity supply must be made by an authorised person in accordance with the Wiring Rules AS/NZS3000.

The supply cable should be positioned so that it does not reach a temperature of more than 75°C.

## **Replacing the power supply lead**

If the supply cord is damaged, it must be replaced by the manufacturer or its service agent or a similarly qualified person in order to avoid hazard.

## **Before leaving**

When the installation is complete, always check for gas leaks using a soapy solution. Never use a flame to make this check.

Ignite all burners on high flame to ensure correct operation of gas valves, burners and ignition. Turn gas taps to low flame position and observe each burner to ensure they ignite completely at all ports and that the flame is stable. Conduct these checks for each burner individually and concurrently.

When satisfied with the hotplate, please instruct the user on the correct method of operation. In case the appliance fails to operate correctly after all checks have been carried out, please call the Technika Service Centre.



## Gas Conversion (NG to U-LPG)

### Parts needed...

- Test Point Assembly
- Auxiliary Jet Ø0.53mm
- Rapid Jet Ø0.88mm
- ULPG Gas Type label
- Semi-Rapid Jet Ø0.68mm
- Wok Jet Ø1.00mm

### Converting to a different gas type

When converting from Natural Gas to Universal LPG ensure that the NG regulator is removed and replaced with the Test Point Assembly supplied in the conversion kit. An AGA Approved gas regulator suitable for a supply pressure of 2.75kPa should be part of the gas tank supply and the test point pressure must be adjusted to 2.75kPa.

### Changing the jets

1. Remove pan supports, burner heads and caps.
2. Use a size 7 socket wrench to unscrew and remove the jets, replacing them with those supplied in the conversion kit. Ensure you use the correct jet for the corresponding burner.
3. Reassemble the burner heads, caps and pan supports.
4. Fit the Gas type label supplied in the conversion kit next to the gas connection point and remove the existing label.



### Setting the minimum level

1. Light one of the burners and turn the tap to minimum flame.
2. Remove the corresponding control knob.
3. Use a thin blade screwdriver to turn the by-pass screw located above left of the gas valve shaft as shown right. Turn the by-pass screw fully clockwise. The result should be a small, stable flame which is uniform around the entire burner ring. If not, turn the by-pass screw anti-clockwise until satisfied with the flame.
4. Check that the burner does not go out when the tap is turned quickly from the maximum to the minimum position.
5. Repeat for each burner.





## Gas Conversion (U-LPG to NG)

### Parts needed...

- |                         |                          |
|-------------------------|--------------------------|
| - NG Regulator          | -NG Gas Type label       |
| - Auxiliary Jet Ø0.88mm | - Semi-Rapid Jet Ø1.16mm |
| - Rapid Jet Ø1.50mm     | - Wok Jet Ø1.75mm        |

### Converting to a different gas type

When converting from Universal LPG to Natural Gas ensure that the ULPG test point is removed and replaced with the AGA Approved NG Regulator supplied in the conversion kit. The test point pressure must be adjusted to 1.00kPa with the largest burner operating on maximum flame.

### Changing the jets

1. Remove pan supports, burner heads and caps.
2. Use a size 7 socket wrench to unscrew and remove the jets, replacing them with those supplied in the conversion kit. Ensure you use the correct jet for the corresponding burner.
3. Reassemble the burner heads, caps and pan supports.
4. Fit the Gas type label supplied in the conversion kit next to the gas connection point and remove the existing label.



### Setting the minimum level

1. Light one of the burners and turn the tap to minimum flame.
2. Remove the corresponding control knob.
3. Use a thin blade screwdriver to turn the by-pass screw located above left of the gas valve shaft as shown right. Turn the by-pass screw fully clockwise then turn it anti-clockwise 1 turn for the Wok, 3/4 turn for the Rapid, 1/2 turn for the Semi-Rapid and 3/8 turn for the Auxiliary. The result should be a small, stable flame which is uniform around the entire burner ring. If not, turn the by-pass screw anti-clockwise until satisfied with the flame.
4. Check that the burner does not go out when the tap is turned quickly from the maximum to the minimum position.
5. Repeat for each burner.





READ THE INSTRUCTION BOOKLET BEFORE INSTALLING AND USING THE APPLIANCE.

The manufacturer will not be responsible for any damage to property or to persons caused by incorrect installation or improper use of the appliance.

The manufacturer is not responsible for any inaccuracies, due to printing or transcription errors, contained in this handout. In addition, the appearance of the figures reported is also purely indicative.

The manufacturer reserves the right to make changes to its products when considered necessary and useful, without affecting the essential safety and operating characteristics.

Technika constantly seeks ways to improve the specifications and designs of their products.

Whilst every effort is made to produce up to date literature, this document should not be regarded as an infallible guide.

Actual product only should be used to derive cut out sizes.

All Technika Appliances must be installed by a qualified person/s with adherence to the relevant electrical, plumbing and gas codes, with compliance being issued as required by state or national legislation.

Additionally all Technika Upright cookers must have chains installed correctly in adherence to the relevant gas and plumbing codes by a Licenced installer.

For maximum effectiveness and efficiency all rangehoods should be installed with the use of ductwork, by a licenced installer with adherence to the relevant state and national building codes and regulations.

All Technika appliances are for Domestic use only, and must be installed by a licenced installer into Domestic Applications only, without exception and to the required Authorities guidelines. Any installation outside of this will VOID warranty. Alfresco areas are not a Domestic application.



---

TECHNIKA PTY LTD ACN 069 686 326  
77 Fillo Drive Someerton Victoria 3062  
General: 1800 649 969 - Service & Spare Parts: 1800 333 244  
Technika After Sales Service - P.O. Box 543 SOMERTON VIC 3061

Version 1 Revision 20110331