

---

*Bellissimo*<sup>™</sup>  
BY TECHNIKA

---

USER GUIDE  
**60CM FREESTANDING DISHWASHER**

TBD4SS-6

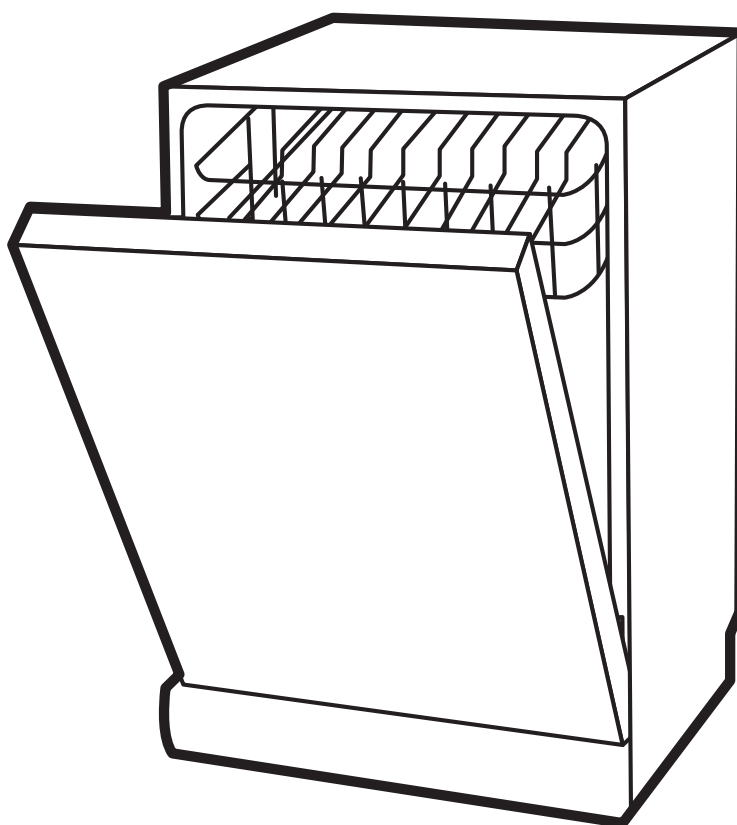



---

# CONTENTS TABLE

---

<b>1. Safety Information</b>	<b>4</b>
<b>2. Product Overview</b>	<b>7</b>
<b>3. Installation Instructions</b>	<b>8</b>
About Power Connection	8
Water Supplier and Drain	9
Connection of Drain Hoses	10
<b>4. Using the Dishwasher</b>	<b>11</b>
Control Panel	11
Function of the Rinse Aid and Detergent	13
Filling the Rinse Aid Dispenser	14
Filling the Detergent Dispenser	14
Basket Use Tips	16
Preparing and Loading Dishes	17
Loading the Baskets According to AS/NZS 2007.1	19
<b>5. Programming the Dishwasher</b>	<b>20</b>
Wash Cycle Table	20
Starting A Cycle Wash	21
Changing The Program Mid-cycle	23
Forgot to Add a Dish	24
<b>6. Maintenance &amp; Cleaning</b>	<b>23</b>
External Care	23
Internal Care	23
Caring for the Dishwasher	26
<b>7. Troubleshooting Tips</b>	<b>29</b>
Error Codes	31
<b>8. Technical Information</b>	<b>32</b>
Product Fiche	33

## Note

- If you cannot solve the problems by yourself, please ask for help from a professional technician.
- The manufacturer, following a policy of constant development and updating of the product, may make modifications without giving prior notice.
- If lost or out-of-date, you can receive a new user manual from the manufacturer or responsible vendor.

### Warnings

---

When using your dishwasher , follow the precautions listed below:

- Installation and repair can only be carried out by a qualified technician
- This appliance is intended to be used in household and similar applications such as:
  - staff kitchen areas in shops, offices and other working environments;
  - farm houses;
  - by clients in hotels, motels and other residential type environments;
  - bed and breakfast type environments.
- Children shall not play with the appliance. Cleaning and user maintenance shall not be done by children without supervision.
- This appliance is not intended for use by persons (including children ) with reduced physical, sensory or mental capabilities, or lack of experience and knowledge, unless they have been given supervision or instruction concerning use of the appliance by a person responsible for their safety. (For IEC60335-1 )
- Packaging material could be dangerous for children!
- This appliance is for indoor household use only. To protect against the risk of electrical shock, do not immerse the unit, cord or plug in water or other liquid.
- Please unplug before cleaning and performing maintenance on the appliance.
- Use a soft cloth moistened with mild soap, and then use a dry cloth to wipe it again.

### Earthing Instructions

---

- This appliance must be earthed. In the event of a malfunction or breakdown, earthing will reduce the risk of an electric shock by providing a path of least resistance of electric current. This appliance is equipped with an earthing conductor plug.
- The plug must be plugged into an appropriate outlet that is installed and earthed in accordance with all local codes and ordinances.
- Improper connection of the equipment-earthing conductor can result in the risk of an electric shock.
- Check with a qualified electrician or service representative if you are in doubt whether the appliance is properly grounded.
- Do not modify the plug provided with the appliance; If it does not fit the outlet.
- Have a proper outlet installed by a qualified electrician.
- Do not abuse, sit on, or stand on the door or dish rack of the dishwasher.
- Do not operate your dishwasher unless all enclosure panels are properly in place.
- Open the door very carefully if the dishwasher is operating, there is a risk of water squirting out.
- Do not place any heavy objects on or stand on the door when it is open. The appliance could tip forward.
- When loading items to be washed:
  - 1) Locate sharp items so that they are not likely to damage the door seal;
  - 2) Warning: Knives and other utensils with sharp points must be loaded in the basket with their points facing down or placed in a horizontal position.
- Some dishwasher detergents are strongly alkaline.
- They can be extremely dangerous if swallowed.
- Avoid contact with the skin and eyes and keep children away from the dishwasher when the door is open.
- Check that the detergent powder is empty after completion of the wash cycle.
- Do not wash plastic items unless they are marked “dishwasher safe” or the equivalent.
- For unmarked plastic items not so marked, check the manufacturer’s recommendations.
- Use only detergent and rinse agents recommended for use in an automatic dishwasher.
- Never use soap, laundry detergent, or hand washing detergent in your dishwasher.
- The door should not be left open, since this could increase the risk of tripping.
- If the supply cord is damaged, it must be replaced by the manufacturer or its service agent or a similarly qualified person in order to avoid a hazard.
- During installation, the power supply must not be excessively or dangerously bent or flattened.
- Do not tamper with controls.
- The appliance needs to be connected to the main water valve using new hose sets. Old sets should not be reused.
- To save energy, in stand by mode , the appliance will switch off automatically while there is no any operation in 30 minutes.
- The maximum number of place settings to be washed is 12.

---

## SAFETY INFORMATION

---

### Disposal

---

- For disposing of package and the appliance please go to a recycling center. Therefore cut off the power supply cable and make the door closing device unusable.
- Cardboard packaging is manufactured from recycled paper and should be disposed in the waste paper collection for recycling.
- By ensuring this product is disposed of correctly, you will help prevent potential negative consequences for the environment and human health, which could otherwise be caused by inappropriate waste handling of this product.
- For more detailed information about recycling of this product, please contact your local city office and your household waste disposal service.
- DISPOSAL: Do not dispose this product as unsorted municipal waste. Collection of such waste separately for special treatment is necessary.

---

# PRODUCT OVERVIEW

---

**IMPORTANT:**

To get the best performance from your dishwasher, read all operating instructions before using it for the first time.

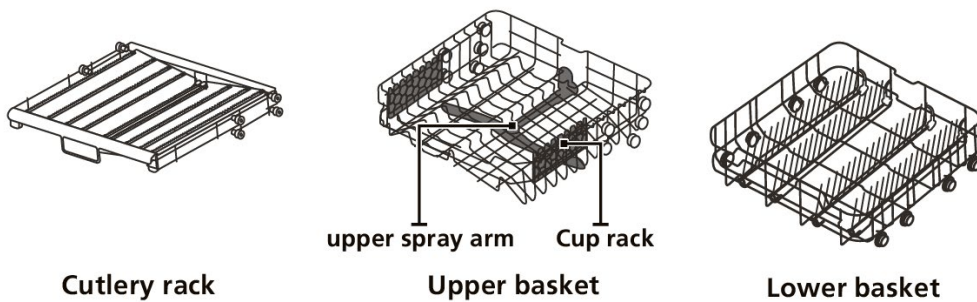
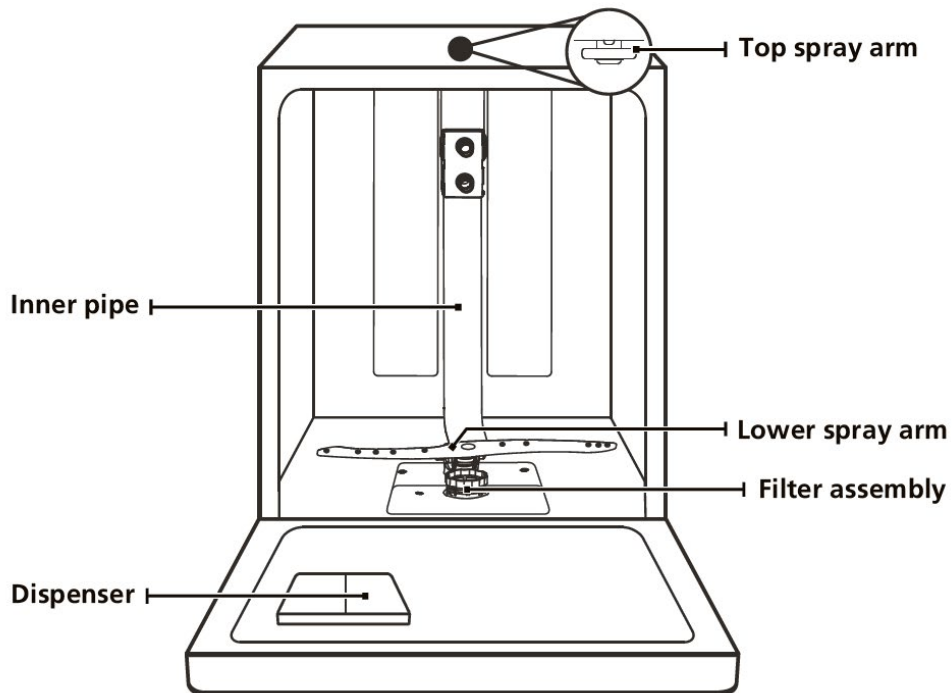

**NOTE:**

Pictures are only for reference, different models may be different. Please prevail in kind.

---

# INSTALLATION INSTRUCTIONS

---



## **Electrical Shock Hazard**

Disconnect electrical power before installing dishwasher. Failure to do so could result in death or electrical shock.

### **Attention**

The installation of the pipes and electrical equipments should be done by professionals.

### **About Power Connection**

#### **WARNING**

##### **For personal safety:**

Do not use an extension cord or an adapter plug with this appliance.

Do not, under any circumstances, cut or remove the earthing connection from the power cord.

### **Electrical Requirements**

Please look at the rating label to know the rating voltage and connect the dishwasher to the appropriate power supply. Use the required fuse 10A/13A/16A, time delay fuse or circuit breaker recommended and provide separate circuit serving only this appliance.

### **Electrical Connection**

Ensure the voltage and frequency of the power being corresponds to those on the rating plate. Only insert the plug into an electrical socket which is earthed properly. If the electrical socket to which the appliance must be connected is not appropriate for the plug, replace the socket, rather than using a adaptors or the like as they could cause overheating and burns.

Ensure that proper erathing exists before use



---

# INSTALLATION INSTRUCTIONS

---

## Position the appliance

Position the appliance in the desired location. The back should rest against the wall behind it, and the sides, along the adjacent cabinets or walls. The dishwasher is equipped with water supply and drain hoses that can be positioned either to the right or left sides to facilitate proper installation.

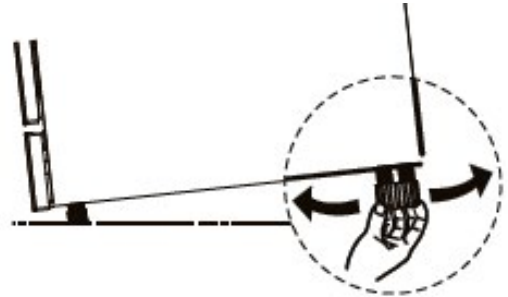

## Levelling the appliance

Once the appliance is positioned for levelling, the height of the dishwasher may be altered via adjustment of the screwing level of the feet. In any case, the appliance should not be inclined more than 2°.

## Water Supply and Drain

### Cold water connection

Connect the cold water supply hose to a threaded 3/4 inch connector and make sure that it is fastened tightly in place. If the water pipes are new or have not been used for an extended period of time, let the water run to make sure that the water is clear. This precaution is needed to avoid the risk of the water inlet to be blocked and damage the appliance.

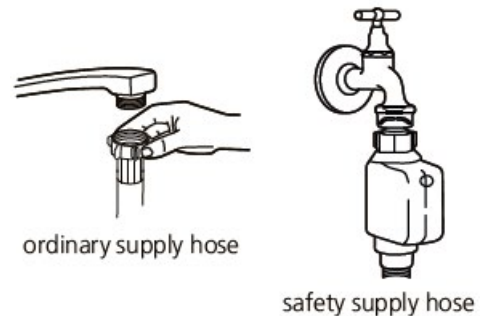

### Warning

The appliance is to be connected to the water mains using new hose sets and that old hose-sets should not be reused.

---

# INSTALLATION INSTRUCTIONS

---

## Connection of Drain Hoses

---

Insert the drain hose into a drain pipe with a minimum diameter of 4 cm, or let it run into the sink, making sure to avoid bending or crimping it. The height of drain pipe must be less than 1000mm. The free end of the hose must not be immersed in water to avoid the back flow of it.

Please securely fix the drain hose in either position A or position B

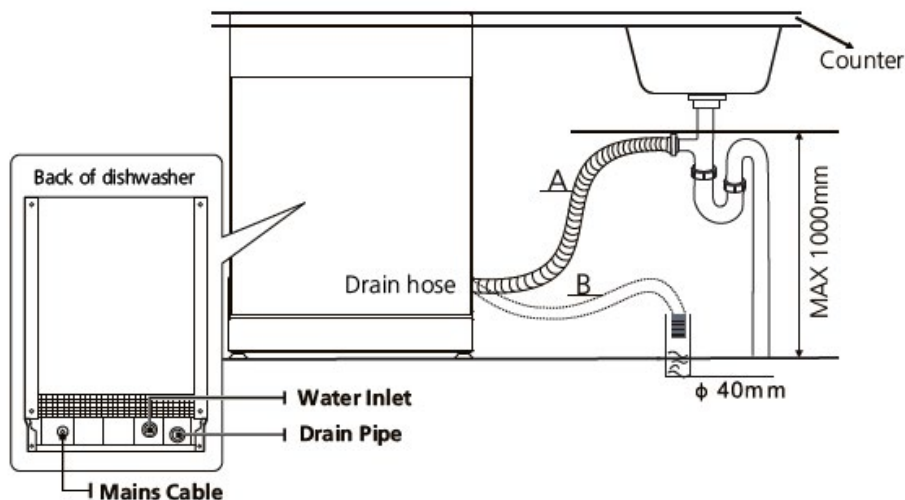

### How to drain excess water from hoses

If the sink is 1000 higher from the floor, the excess water in hoses cannot be drained directly into the sink. It will be necessary to drain excess water from hoses into a bowl or suitable container that is held outside and lower than the sink.

### Water outlet

Connect the water drain hose. The drain hose must be correctly fitted to avoid water leaks. Ensure that the water drain hose is not kinked or squashed.

### Extension hose

If you need a drain hose extension, make sure to use a similar drain hose. It must be no longer than 4 meters; otherwise the cleaning effect of the dishwasher could be reduced.

### Syphon connection



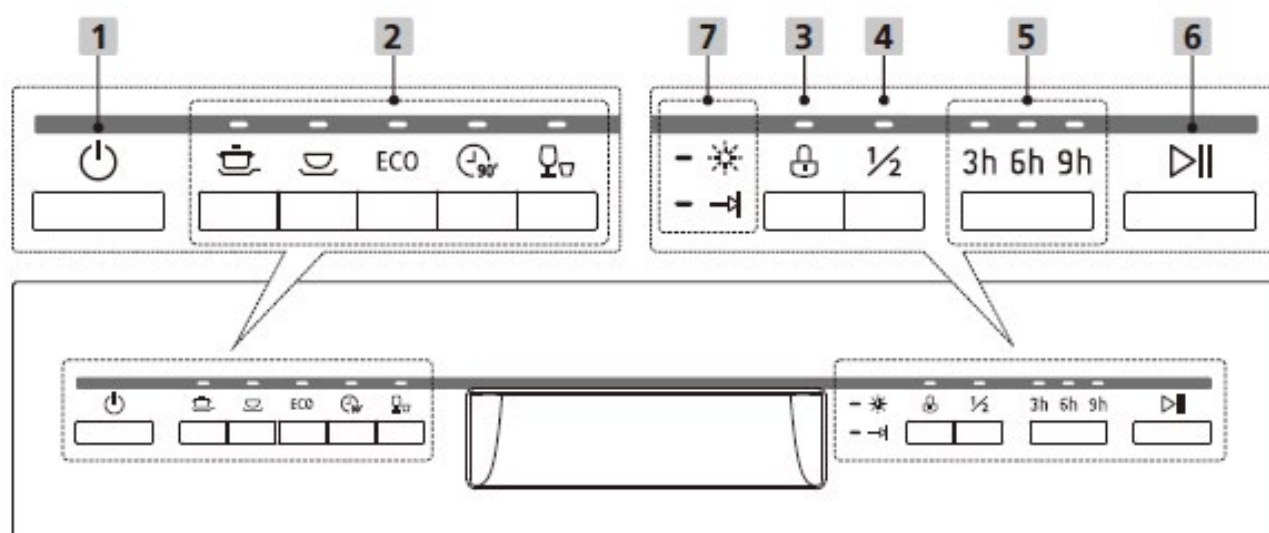

The waste connection must be at a height less than 100 cm (maximum) from the bottom of the dish. The water drain hose should be fixed.

# USING THE DISHWASHER

## Control Panel



## Operation (Button)

<b>1 Power</b>	Press this button to turn on your dishwasher.
<b>2 Program</b>	<p>Select the appropriate washing program, the selected program indicator will be lit.</p> <ul style="list-style-type: none"> <li> <b>Intensive</b> For heaviest soiled crockery, such as pots, pans, casserole dishes and dishes that have been sitting with dried food on them for some time.</li> <li> <b>Heavy</b> For heavily soiled loads, such as pots, plates, glasses and lightly soiled pans.</li> <li><b>ECO</b> <b>ECO</b> For normally soiled loads, such as pots, plates, glasses and lightly soiled pans, standard everyday cycle.</li> <li> <b>90 min</b> For lightly soiled plates and pans that need quick wash.</li> <li> <b>Rapid</b> A shorter wash for lightly soiled loads that do not need drying.</li> </ul>



---

## USING THE DISHWASHER

---

<b>3 Child lock</b>	This option allows you to lock the buttons on the control panel, so children cannot accidentally start the dishwasher by pressing the buttons for 3s on the panel. Only the Power button remains active.
<b>4 Half-load</b>	When you have about or less than half of full place settings dishware to wash, you can choose this function to save energy and water. (It can only be used with Intensive, Heavy, ECO and 90 min.)
<b>5 Delay</b>	Press the button to set the delay time (3h, 6h, 9h), corresponding indicator will be lit.
<b>6 Start/Pause</b>	Press the button to start the selected washing program or pause the working program.

### Display

<b>7 Warning indicators</b>	 Rinse Aid If the "  " indicator is lit, it means the dishwasher is low on dishwasher rinse aid and requires a refill.   Program end when the program is end, the indicator will be lit.
-----------------------------	---

---

# USING THE DISHWASHER

---

## Function Of The Rinse Aid And Detergent

---

The rinse aid is released during the final rinse to prevent water from forming droplets on your dishes, which can leave spots and streaks. It also improves drying by allowing water to roll off the dishes. Your dishwasher is designed to use liquid rinse aids.

### Warning

Only use branded rinse aid for dishwasher. Never fill the rinse aid dispense with any other substances (e.g Dishwasher cleaning agent, liquid detergent). This would damage the appliance.

### When to refill the rinse aid dispenser

Unless the rinse-aid warning light ( ✱ ) on the control panel is on, you can always estimate the amount from the colour of the optical level indicator located next to the cap. When the rinse-aid container is full, the indicator will be fully dark. The size of the dark dot decreases as the rinse-aid diminishes. You should never let the rinse aid level be less than 1/4 full.

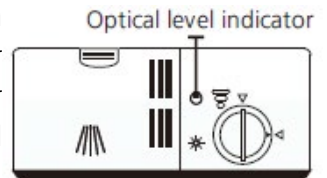

As the rinse aid diminishes, the size of the black dot on the rinse aid level indicator changes, as

● Full   ● 3/4 full   ● 1/2 full   ● 1/4 full   ○ Empty

### Function of detergent

The chemical ingredients that compose the detergent are necessary to remove, crush and dispense all dirt out of the dishwasher. Most of the commercial quality detergents are suitable for this purpose.

### WARNING

- Property Use of Detergent

Use only detergent specifically made for dishwashers use. Keep your detergent fresh and dry.



Don't put powdered detergent into the dispenser until you are ready to wash dishes.

- Dishwasher detergent is corrosive! Keep dishwasher detergent out of the reach of children.

---

# USING THE DISHWASHER

---

## Filling The Rinse Aid Dispenser

---

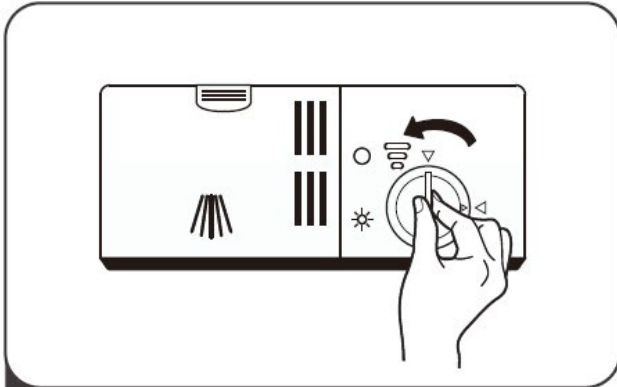

- 1** Remove the rinse aid reservoir cap by rotating it counterclockwise.

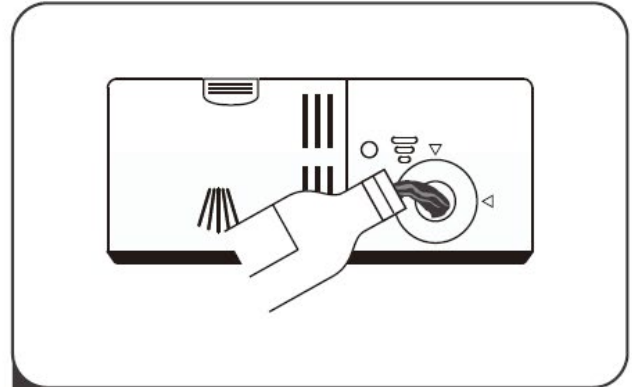

- 2** Carefully pour in the rinse-aid into its dispenser, whilst avoiding it to overflow.

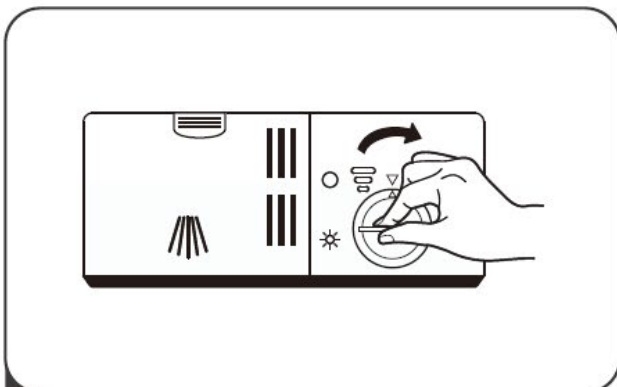

- 3** Close the rinse aid reservoir cap by rotating it clockwise.

**NOTE:**

Clean up any spilled rinse aid with an absorbent cloth to avoid excessive foaming during the next wash.



**Adjusting the rinse aid reservoir**

Turn the rinse aid indicator dial to a number. The higher the number, the more rinse aid the dishwasher uses. If the dishes are not drying properly or are spotted, adjust the dial to the next higher number until your dishes are spot-free. Reduce it if there are sticky whitish stains on your dishes or a bluish film on glassware or knife blades.



---

# USING THE DISHWASHER

---

## Filling The Detergent Dispenser

---

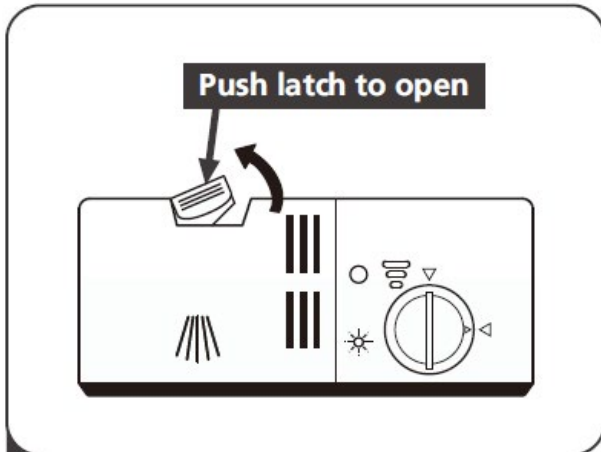

**1** Press the release catch on the detergent dispenser to open the cover.

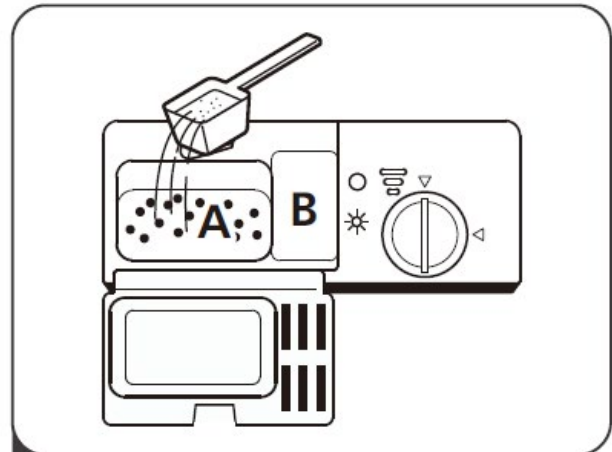

**2** Add detergent into the larger cavity (A) for the main wash cycle .  
For more heavily soiled wash loads, also add some detergent into the smaller cavity (B) for the pre-wash cycle .

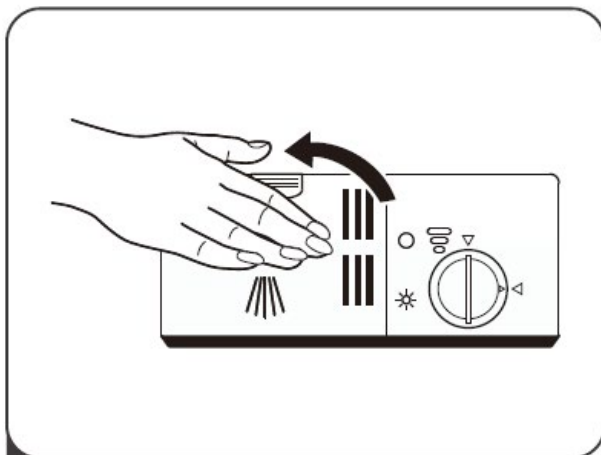

**3** Close the cover and press on it until it locks into place.

### Note:

- Be aware that depending on the soiling of water, setting may be different.
- Please observe the manufacturer's recommendations on the detergent packaging.

# USING THE DISHWASHER

## Basket Use Tips

### Adjusting the upper basket

#### Type 1:

The height of the upper basket can be easily adjusted to accommodate taller dishes in either the upper or lower basket.

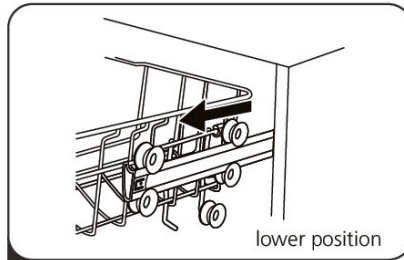

1 Pull out the upper basket.

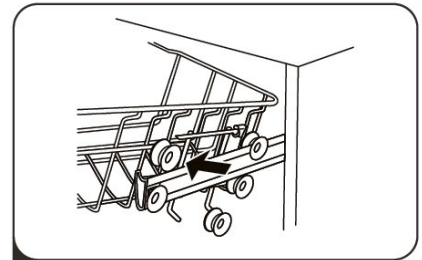

2 Remove the upper basket.

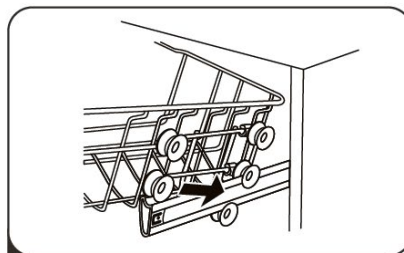

3 Re-attach the upper basket to upper or lower rollers.

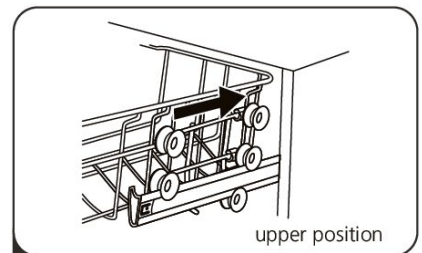

4 Push in the upper basket.

#### Type 2:

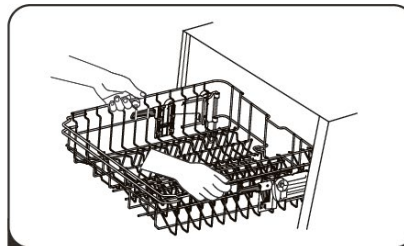

1 To raise the upper basket, just lift the upper basket at the center of each side until the basket locks into place in the upper position. It is not necessary to lift the adjuster handle.

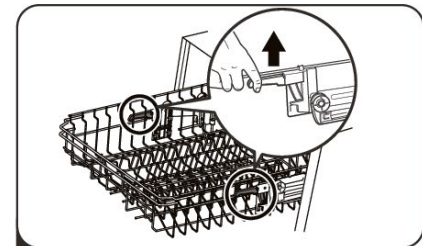

2 To lower the upper basket, lift the adjust handles on each side to release the basket and lower it to the lower position.

### Folding back the cup shelves

To make room for taller items in the upper basket, raise the cup rack upwards. You can then lean the tall glasses against it. You can also remove it when it is not required for use.

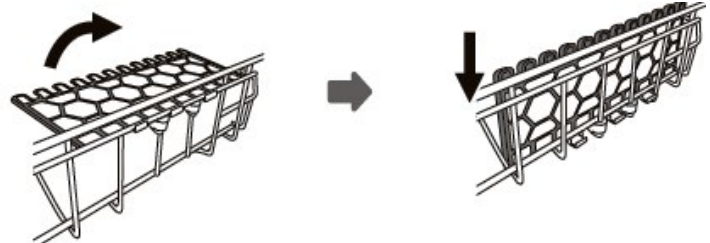

### Folding back the rack shelves

The spikes of the lower basket are used for holding plates and a platter. They can be lowered to make more room for large items.

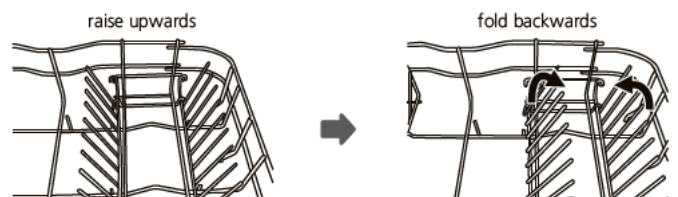



---

# USING THE DISHWASHER

---

## Preparing and Loading Dishes

---

- Consider buying utensils which are identified as dishwasher-proof.
- For particular items, select a program with the lowest possible temperature.
- To prevent damage, do not take glass and cutlery out of the dishwasher immediately after the program has ended.

### For washing the following cutlery/dishes

#### Are not suitable

- Cutlery with wooden, horn china or mother-of-pearl handles
- Plastic items that are not heat resistant
- Older cutlery with glued parts that are not temperature resistant
- Bonded cutlery items or dishes
- Pewter or copper items
- Crystal glass
- Steel items subject to rusting
- Wooden platters
- Items made from synthetic fibres

#### Are of limited suitability

- Some types of glasses can become dull after a large number of washes
- Silver and aluminum parts have a tendency to discolor during washing
- Glazed patterns may fade if machine washed frequently

### Recommendations for loading the dishwasher

Scrape off any large amounts of leftover food. Soften remnants of burnt food in pans. It is not necessary to rinse the dishes under running water. For best performance of the dishwasher, follow these loading guidelines. (Features and appearance of baskets and cutlery baskets may vary from your model.)

Place objects in the dishwasher in following way:

- Items such as cups, glasses, pots, pans, etc. are faced downwards.
- Curved items, or ones with recesses, should be loaded aslant so that water can run off.
- All utensils are stacked securely and can not tip over.
- All utensils are placed in the way that the spray arms can rotate freely during washing.
- Load hollow items such as cups, glasses, pans etc. With the opening facing downwards so that water cannot collect in the container or a deep base.
- Dishes and items of cutlery must not lie inside one another, or cover each other.
- To avoid damage, glasses should not touch one another.
- The upper basket is designed to hold more delicate and lighter dishware such as glasses, coffee and tea cups.
- Long bladed knives stored in an upright position are a potential hazard!
- Long and sharp items of cutlery such as carving knives must be positioned horizontally in the upper basket.
- Please do not overload your dishwasher. This is important for good results and for reasonable consumption of energy.

**NOTE:** Very small items should not be washed in the dishwasher as they could easily fall out of the basket.

---

---

## USING THE DISHWASHER

---

### Loading the upper basket

The upper basket is designed to hold more delicate and lighter dishware such as glasses, coffee and tea cups and saucers, as well as plates, small bowls and shallow pans (as long as they are not too dirty). Position the dishes and cookware so that they will not get moved by the spray of water.



### Loading the lower basket

We suggest that you place large items and the most difficult to clean items are to be placed into the lower basket: such as pots, pans, lids, serving dishes and bowls, as shown in the figure below. It is preferable to place serving dishes and lids on the side of the racks in order to avoid blocking the rotation of the top spray arm. The maximum diameter advised for plates in front of the detergent dispenser is of 19 cm, this not to hamper the opening of it.



### Loading the cutlery tray

Cutlery should be placed in the cutlery tray separately from each other in the appropriate positions, and make sure the utensils do not nest together, this may cause bad performance.

### WARNING

Do not let any item extend through the bottom.  
Always load sharp utensils with the sharp point down!

### Note:

For the best wash results, please refer to standard loading options in section 5.

### Removing the dishes

To prevent water dripping from the upper basket into the lower basket, we recommend that you empty the lower basket first, followed by the upper basket.

### WARNING

Items will be hot! To prevent damage, do not take glass and cutlery out of the dishwasher for around 15 minutes after the program has ended.

# USING THE DISHWASHER

## Loading The Baskets According To AS/NZS 2007.16

### 1. Upper basket:

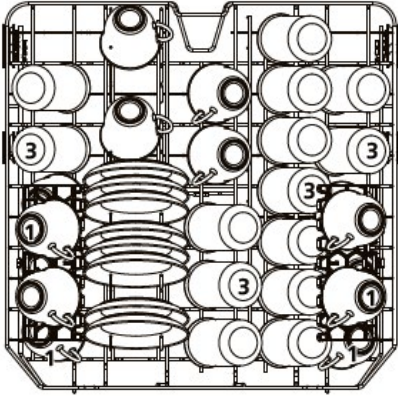

Number	Item
1	Cups
2	Saucers
3	Glasses

### 2. Lower basket:

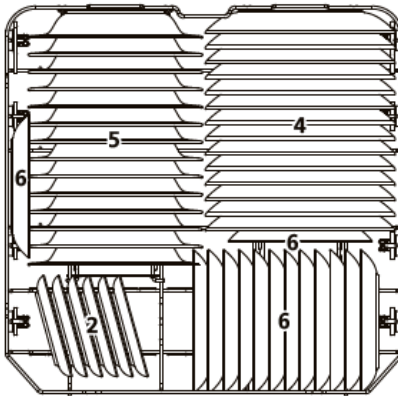

Number	Item
4	Dinner plates
5	Soup plates
6	Dessert dishes

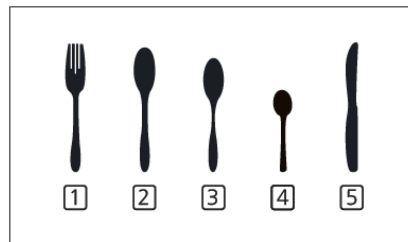
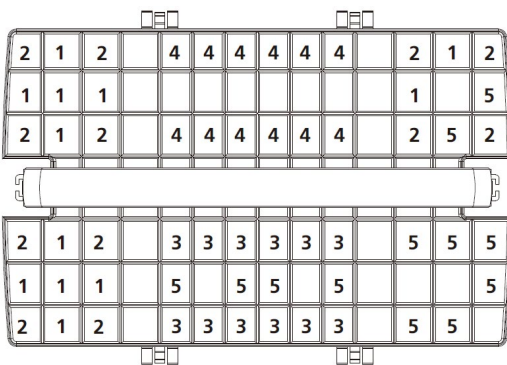

Number	Item
1	Forks
2	Soup spoons
3	Dessert spoons
4	Teaspoons
5	Knives

Information for comparability tests in accordance with (\*AS/NZS 2007.1)

Capacity: 12 place settings

Position of the upper basket: lower position

Program: ECO

Rinse aid setting: 6

Detergent(Pre/main): 5/25g





Door is open at the end of the drying cycle for the drying performance test

(Door position: Open 50 mm)

# PROGRAMMING THE DISHWASHER

## Wash Cycle Table

The table below shows which programs are best for the levels of food residue on them and how much detergent is needed. It also show various information about the programs.  
 (●)Means: need to fill rinse into the Rinse-Aid Dispenser.

Program	Description Of Cycle	Detergent Pre/Main	Running Time(min)	Energy (Kwh)	Water (L)	Rinse Aid
 <b>Intensive</b>	Pre-wash(50°C) Wash(60°C) Rinse Rinse Rinse(65°C) Drying	$\frac{5}{25g}$ (1 or 2 pieces)	170	1.6	18.5	●
 <b>Heavy</b>	Pre-wash(45°C) Wash(55°C) Rinse Rinse(65°C) Drying	$\frac{5}{25g}$ (1 or 2 pieces)	160	1.4	15	●
<b>ECO</b> <small>AS/NZS 2007.1)</small>	Wash(45°C) Rinse Rinse(45°C) Drying	$\frac{5}{25g}$ (1 or 2 pieces)	185	0.74	11	●
 <b>90 min</b>	Wash(65°C) Rinse Rinse(65°C) Drying	$\frac{30g}{(1 or 2 pieces)}$	90	1.2	11.5	●
 <b>Rapid</b>	Wash(40°C) Rinse Rinse(45°C)	25g	30	0.6	11.5	○

**Note:**

AS/NZS 2007.1: This program is the test cycle. The information for comparability test in accordance with AS/NZS 2007.1.

ECO is the program recommended for a normally soiled load at rated capacity.

---

# PROGRAMMING THE DISHWASHER

---

## Starting A Wash Cycle

---

1. Draw out the lower and upper basket, load the dishes and push them back. It is commended to load the lower basket first, then the upper one.
2. Pour in the detergent.
3. Insert the plug into the socket. The power supply refer to last page "Product fiche". Make sure that the water supply is turned on to full pressure.
4. Close the door, press the Power button, to switch on the machine.
5. Choose a program, the response light will turn on. Then press the Start/Pause button, the dishwasher will start its cycle.

## Changing The Program Mid-cycle

---

A wash cycle can only be changed if it has been running for a short time otherwise, the detergent may have already been released and the dishwasher may have already drained the wash water. If this is the case, the dishwasher needs to be reset and the detergent dispenser must be refilled. To reset the dishwasher, follow the instructions below:

1. Press the Start/Pause button to pause the washing.
2. Press the Program button for more than 3 seconds, the dishwasher will enter standby mode.
3. Press the Program button to select the desired program.
4. Press the Start/Pause button, the dishwasher will run after 10 seconds.

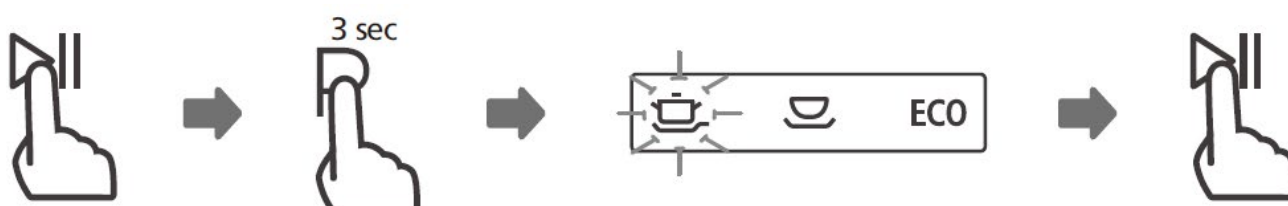

---

## PROGRAMMING THE DISHWASHER

---

### Forget To Add A Dish

---

A forgotten dish can be added any time before the detergent dispenser opens. If this is the case, follow the instructions below:

1. Press the Start/Pause button to pause the washing.
2. After the spray arms stop working, you can open the door completely.
3. Add the forgotten dishes.
4. Close the door.
5. Press the Start/Pause button after 10 seconds, the dishwasher will start.

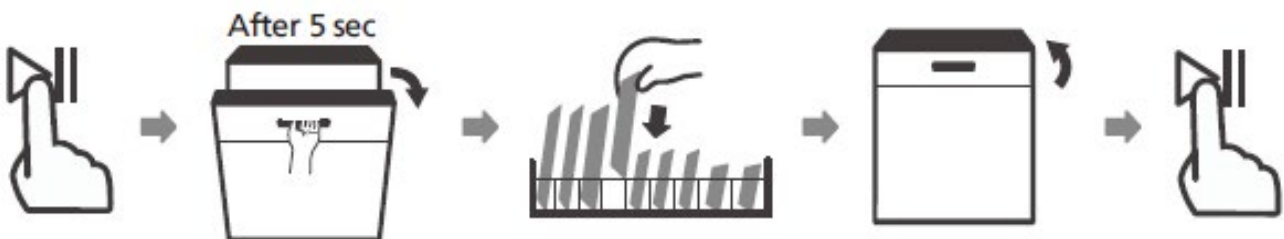

#### **WARNING**

It is dangerous to open the door mid-cycle, as hot steam may scald you.

---

# MAINTENANCE AND CLEANING

---

## Care

---

### External Care

#### The door and the door seal

Clean the door seals regularly with a soft damp cloth to remove food deposits.

When the dishwasher is being loaded, food and drink residues may drip onto the sides of the dishwasher door. These surfaces are outside the wash cabinet and are not accessed by water from the spray arms. Any deposits should be wiped off before the door is closed.

#### The control panel

If cleaning is required, the control panel should be wiped with a soft damp cloth only.

### WARNING

- To avoid penetration of water into the door lock and electrical components,
- do not use a spray cleaner of any kind.
- Never use abrasive cleaners or scouring pads on the outer surfaces because they may scratch the finish. Some paper towels may also scratch or leave marks on the surface.

### Internal Care

#### Filtering system

The filtering system in the base of the wash cabinet retains coarse debris from the washing cycle. The collected coarse debris may cause the filters to clog. Check the condition of the filters regularly and clean them if necessary under running water. Follow the steps below to clean the filters in the wash cabinet.

### NOTE:

Pictures are only for reference, different models of the filtering system and spray arms may be different.

---

## MAINTENANCE AND CLEANING

---

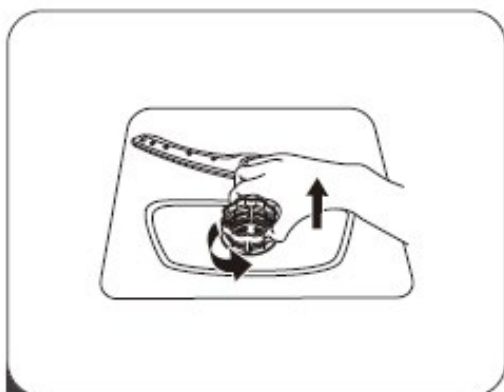

- 1** Hold the coarse filter and rotate it anticlockwise to unlock the filter. Lift the filter upwards and out of the dishwasher.

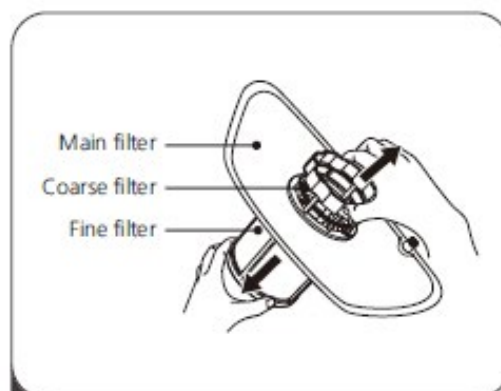

- 2** The fine filter can be pulled off the bottom of the filter assembly. The coarse filter can be detached from the main filter by gently squeezing the tabs at the top and pulling it away.

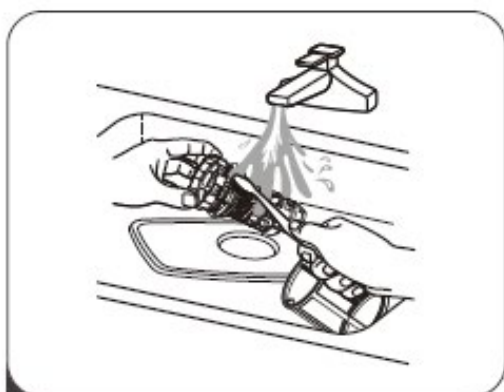

- 3** Larger food remnants can be cleaned by rinsing the filter under running water. For a more thorough clean, use a soft cleaning brush.

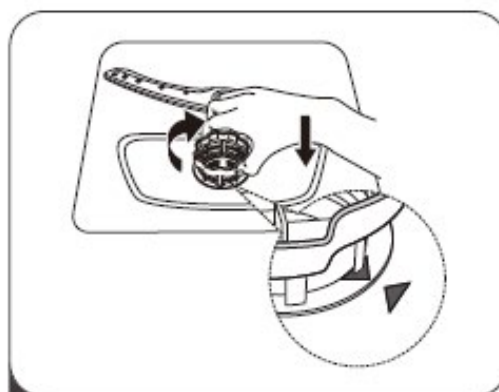

- 4** Reassemble the filters in the reverse order of the disassembly, replace the filter insert, and rotate clockwise to the close arrow.

### WARNING

Do not over tighten the filters. Put the filters back in sequence securely, otherwise coarse debris could get into the system and cause a blockage. Never use the dishwasher without filters in place. Improper replacement of the filter may reduce the performance level of the appliance and damage dishes and utensils.



---

## MAINTENANCE AND CLEANING

---

### Spray arms

Wash the arms in soapy and warm water and use a soft brush to clean the jets. Replace them after rinsing them thoroughly.

It is necessary to clean the spray arms regularly for hard water chemicals will clog the spray arm jets and bearings.

To clean the spray arms, follow the instructions below:

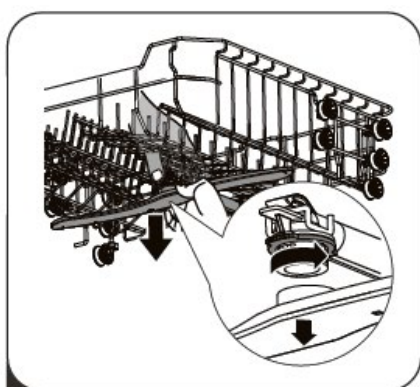

- 1** To remove the upper spray arm, hold the nut in the center still and rotate the spray arm counterclockwise to remove it.



- 2** To remove the lower spray arm, pull out the spray arm upward.

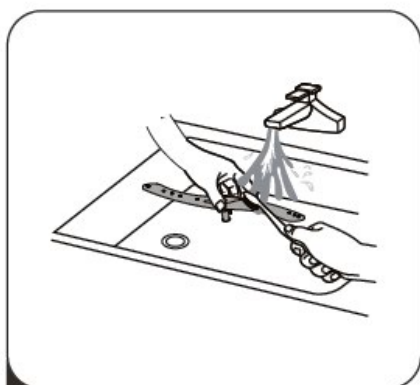

- 3** Wash the arms in soapy and warm water and use a soft brush to clean the jets. Replace them after rinsing them thoroughly.

---

## MAINTENANCE AND CLEANING

---

### Caring For The Dishwasher

---

#### **Frost precaution**

Please take frost protection measures on the dishwasher in winter. Every time after washing cycles, please operate as follows:

1. Cut off the electrical power to the dishwasher at the supply source.
2. Turn off the water supply and disconnect the water inlet pipe from the water valve.
3. Drain the water from the inlet pipe and water valve. (Use a pan to gather the water)
4. Reconnect the water inlet pipe to the water valve.
5. Remove the filter at the bottom of the tub and use a sponge to soak up water in the sump.

#### **After every wash**

After every wash, turn off the water supply to the appliance and leave the door slightly open so that moisture and odors are not trapped inside.

#### **Remove the plug**

**Before cleaning or performing maintenance, always remove the plug from the socket.**

#### **No solvents or abrasive cleaning**

To clean the exterior and rubber parts of the dishwasher, do not use solvents or abrasive cleaning products. Only use a cloth with warm soapy water. To remove spots or stains from the surface of the interior, use a cloth dampened with water and a little vinegar, or a cleaning product made specifically for dishwashers.

#### **When not in use for a longtime**

It is recommended that you run a wash cycle with the dishwasher empty and then remove the plug from the socket, turn off the water supply and leave the door of the appliance slightly open. This will help the door seals to last longer and prevent odors from forming within the appliance.

#### **Moving the appliance**

If the appliance must be moved, try to keep it in the vertical position. If absolutely necessary, it can be positioned on its back.

#### **Seals**

One of the factors that cause odours to form in the dishwasher is food that remains trapped in the seals. Periodic cleaning with a damp sponge will prevent this from occurring.

---

## TROUBLESHOOTING TIPS

---

<b>Problem</b>	<b>Possible Causes</b>	<b>What To Do</b>
Dishwasher doesn't start	Fuse blown, or the circuit break tripped.	Replace fuse or reset circuit breaker. Remove any other appliances sharing the same circuit with the dishwasher.
	Power supply is not turned on.	Make sure the dishwasher is turned on and the door is closed securely. Make sure the power cord is properly plugged into the wall socket.
	Water pressure is low	Check that the water supply is connected properly and the water is turned on.
	Door of dishwasher not properly closed.	Make sure to close the door properly and latch it.
Water not pumped form dishwasher	Twisted or trapped drain hose.	Check the drain hose.
	Filter clogged.	Check coarse the filter.
	Kitchen sink clogged.	Check the kitchen sink to make sure it is draining well. If the problem is the kitchen sink that is not draining, you may need a plumber rather than a serviceman for dishwashers.
Suds in the tub	Wrong detergent.	Use only the special dishwasher detergent to avoid suds. If this occurs, open the dishwasher and let suds evaporate. Add 1 gallon of cold water to the bottom of the dishwasher. Close the dishwasher door, then select any cycle. Initially, the dishwasher will drain out the water. Open the door after draining stage is complete and check if the suds have disappeared. Repeat if necessary.

---

## TROUBLESHOOTING TIPS

<b>Problem</b>	<b>Possible Causes</b>	<b>What To Do</b>
	Spilled rinse-aid.	Always wipe up rinse-aid spills immediately.
Stained tub interior	Detergent with colourant may have been used.	Make sure that the detergent has no colourant.
White film on inside surface	Hard water minerals.	To clean the interior, use a damp sponge with dishwasher detergent and wear rubber gloves. Never use any other cleaner than dishwasher detergent otherwise, it may cause foaming or suds.
There are rust stains on cutlery	The affected items are not corrosion resistant.	The items should be corrosion resistant.
Knocking noise in the dishwasher	A spray arm is knocking against an item in a basket	Interrupt the program and rearrange the items which are obstructing the spray arm.
Rattling noise in the dishwasher	Items of crockery are loose in the dishwasher.	Interrupt the program and rearrange the items of crockery.
Knocking noise in the water pipes	This may be caused by on-site installation or the cross-section of the piping.	This has no influence on the dishwasher function. If in doubt, contact a qualified plumber.
The dishes are not clean	The dishes were not loaded correctly.	See notes in "Loading & unloading your dishwasher".
	The program was not powerful enough.	Select a more intensive program.

## TROUBLESHOOTING TIPS

<b>Problem</b>	<b>Possible Causes</b>	<b>What To Do</b>
The dishes are not clean.	Not enough detergent was dispensed.	Use more detergent, or change your detergent.
	Items are blocking the movement of the spray arms.	Rearrange the items so that the spray can rotate freely.
	The filter combination is not clean or is not correctly fitted in the base of wash cabinet. This may cause the spray arm jets to get blocked.	Clean and/or fit the filter correctly. Clean the spray arm jets.
Cloudiness on glassware.	Combination of soft water and too much detergent.	Use less detergent if you have soft water and select a shorter cycle to wash the glassware and to get them clean.
Black or grey marks on dishes	Aluminium utensils have rubbed against dishes	Use a mild abrasive cleaner to eliminate those marks.
Detergent left in dispenser	Dishes block detergent dispenser	Re-loading the dishes properly.
The dishes aren't drying	Improper loading	Load the dishwasher as suggested in the directions.
	Too little rinse-aid	Increase the amount of rinse-aid/refill the rinse-aid dispenser.
	Dishes are removed too soon	Do not empty your dishwasher immediately after washing. Open the door slightly so that the steam can come out. Take out the dishes until the inside temperature is safe to touch. Unload the lower basket first to prevent the dropping water from the upper basket.

---

## TROUBLESHOOTING TIPS

---

---

<b>Problem</b>	<b>Possible Causes</b>	<b>What To Do</b>
The dishes aren't drying	Wrong program has been selected.	With a short program, the washing temperature is lower, decreasing cleaning performance. Choose a program with a long washing time.
	Use of cutlery with a low-quality coating.	Water drainage is more difficult with these items. Cutlery or dishes of this type are not suitable for washing in the dishwasher.

---

---

## ERROR CODES

---

If there is a malfunction, the dishwasher will display error codes to identify these:se only non caustic oven cleaners purchased from hardware stores or supermarkets.

Codes	Meanings	Possible Causes
The Rapid light flicker fleetly	Longer inlet time.	Faucets is not opened, or water intake is restricted, or water pressure is too low.
The Rapid, 90 min light flicker fleetly	Not reaching required temperature.	Malfunction of heating element.
The ECO light flicker fleetly	Overflow.	Some element of dishwasher leaks.
The Heavy, ECO, Rapid light flicker fleetly	Failure of communication between main PCB with display PCB.	Open circuit or break wiring for the communication.

**WARNING:**

- If overflow occurs, turn off the main water supply before calling a service.
- If there is water in the base pan because of an overfill or small leak, the water should be removed before restarting the dishwasher.

---

## TECHNICAL INFORMATION

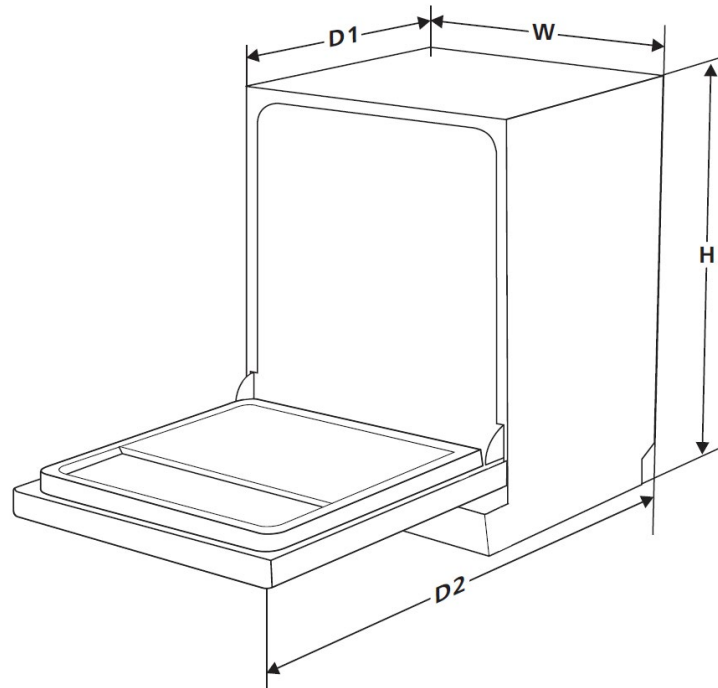

---



<b>Height (H)</b>	845mm
<b>Width (W)</b>	598mm
<b>Depth (D1)</b>	600mm (with the door closed)
<b>Depth (D2)</b>	1175mm (with the door opened 90° )



## PRODUCT FISHE

Manufacturer	Bellissimo
Type / Description	TBD4SS-6
Standard place settings	12
Energy efficiency class	 <span style="background-color: #333; color: white; padding: 2px 5px; font-weight: bold;">3.0</span>
Water consumption class	 <span style="background-color: #333; color: white; padding: 2px 5px; font-weight: bold;">4.5</span>
Standard cleaning cycle	ECO
Energy consumption of the standard cleaning cycle	0.74 kWh
Water consumption of the standard cleaning cycle	11 litre
Program duration of the standard cleaning cycle	185 min
Water pressure (flow pressure)	0.04-1.0MPa=0.4-10 bar
Mounting	Freestanding
Could be built-in	YES
Power consumption	1760-2100W
Rated voltage / frequency	AC 220-240V/50Hz

---

# MANUFACTURER GUARANTEE

---

This warranty is provided in Australia by Glen Dimplex Australia Pty Limited ABN 69 118 275 460 **(Phone number 1300 556 816)** and in New Zealand by Glen Dimplex New Zealand Limited NZBN 9429000069823 **(Phone number 09 274 8265)** in respect of the **Bellissimo** product.

## 1. Bellissimo Express Warranty

Subject to the exclusions below, we warrant that the product will not have any electrical or mechanical breakdowns within:

- a) In the case of **Bellissimo** products used for personal, domestic or household purposes, a period of 2 years from the date the product is purchased as a brand-new product from a retailer located in Australia / New Zealand.
- b) In the case of **Bellissimo** products used for purposes other than personal, domestic or household purposes (including business or commercial use), a period of 90 days from the date the product is purchased as a brand-new product from a retailer located in Australia / New Zealand. **Bellissimo** products are designed and intended for domestic use only; and
- c) All warranty repairs must be carried out by Glen Dimplex or their nominated service agent

**Note: warranty periods detailed above may vary in line with agreements with select retail and builder partners and may differ between Australia and New Zealand.**

The benefits conferred by this express warranty are in addition to the Consumer Guarantees referred to in section 3 and any other statutory rights you may have under the Australian / New Zealand Consumer Law and/or other applicable laws.

## 2. Warranty exclusions

This express warranty does not apply where:

- a) The product has been installed, used or operated otherwise than in accordance with the product manual or other similar documentation provided to you with the product;

---

## MANUFACTURER GUARANTEE

---

- b) The product requires repairs due to damage resulting from accident, misuse, incorrect installation, insect or vermin infestation, improper liquid spillage, cleaning or maintenance, unauthorised modification, use on an incorrect voltage, power surges and dips, voltage supply problems, tampering or unauthorised repairs by any persons, use of defective or incompatible accessories or exposure to abnormally corrosive conditions, events independent of human control which occurred after the goods left the control of Glen Dimplex;
- c) The repair relates to the replacement of consumable parts such as fuses and bulbs or any other parts of the product which require routine replacement;
- d) You are unable to provide us with reasonable proof of purchase for the product;
- e) the breakdown occurs after the expiry of the express warranty period set out in section 1 or
- f) the product was not purchased in Australia / New Zealand as a brand-new product.

### **3. Consumer guarantees**

Our goods come with guarantees that cannot be excluded under the Australian / New Zealand Consumer Law. You are entitled to a replacement or refund for a major failure and for compensation for any other reasonably foreseeable loss or damage. You are also entitled to have the goods repaired or replaced if the goods fail to be of acceptable quality and the failure does not amount to a major failure.

### **4. How to make a claim**

You may make a claim under this warranty through our website, contacting our customer care line or via email. Contact details for Glen Dimplex Australia and New Zealand can be found at the end of this document

To make a valid claim under this warranty, you must:

- a) Lodge the claim with us as soon as possible and no later than 14 days after you first become aware of the breakdown;
- b) Provide us with the product serial number;
- c) Provide us with reasonable proof of purchase for the product. This can take the form of a store receipt, new home handover form or other payment receipt documentation; and
- d) If required by us, provide us (or any person nominated by us) with access to the premises at which the product is located at times nominated by us (so that we can inspect the product).

---

## MANUFACTURER GUARANTEE

---

### 5. Warranty claims

If you make a valid claim under this warranty and none of the exclusions set out in section 2 apply, we will, at our election, either repair the product or replace the product with a product of identical specification (or where the product is superseded or no longer in stock, with a product of as close a specification as possible).

Goods presented for repair may be replaced by refurbished goods of the same type rather than being repaired. Refurbished parts may be used to repair the goods.

Products are designed and supplied for normal domestic use. We will not be liable to you under this warranty for business loss or damage of any kind whatsoever.



#### **Glen Dimplex Australia Pty Ltd**

[www.glendimplex.com.au](http://www.glendimplex.com.au)

#### **Australia**

Ph: 1300 556 816

[customer.care.ha@glendimplex.com.au](mailto:customer.care.ha@glendimplex.com.au)

#### **Glen Dimplex New Zealand Ltd**

[www.glendimplex.co.nz](http://www.glendimplex.co.nz)

#### **New Zealand**

Ph: 09 274 8265

[nztechserv@glendimplex.co.nz](mailto:nztechserv@glendimplex.co.nz)

---

# NOTES

---

---

# MANUFACTURER GUARANTEE

---

## **READ THE INSTRUCTION BOOKLET BEFORE INSTALLING AND USING THE APPLIANCE.**

The manufacturer will not be responsible for any damage to property or to persons caused by incorrect installation or improper use of the appliance.

The manufacturer is not responsible for any inaccuracies, due to printing or transcription errors, contained in this manual. In addition, the appearance of the figures reported is also purely indicative.

The manufacturer reserves the right to make changes to its products when considered necessary and useful, without affecting the essential safety and operating characteristics.

Glen Dimplex constantly seeks ways to improve the specifications and designs of their products.

Whilst every effort is made to produce up to date literature, this document should not be regarded as an infallible guide. Actual product only should be used to derive cut out sizes.

All appliances must be installed by a qualified person/s with adherence to the relevant electrical, plumbing and building codes, with compliance being issued as required by state or national legislation.

Additionally, all upright cookers must have the anti-tilt device installed correctly in adherence to the relevant standards by a licenced installer. For maximum effectiveness and efficiency all rangehoods should be installed with the use of ductwork, by a licenced installer with adherence to the relevant state and national building codes and regulations.

All Glen Dimplex appliances are for Domestic use only, and must be installed by a licence installer into Domestic Applications only, without exception and to the required Authorities guidelines. Any installation outside of this will VOID warranty. Alfresco areas are not a Domestic application.

Distributed by:

### **Glen Dimplex Australia Pty Ltd**

For full terms and conditions, or to register your product warranty, please visit our website:

[www.glendimplex.com.au](http://www.glendimplex.com.au)

### **Glen Dimplex New Zealand Ltd**

[www.glendimplex.co.nz](http://www.glendimplex.co.nz)

For service advice, please contact the Customer Care Centre by phone or email below.

#### **Australia**

Ph: 1300 556 816

[customer.care.ha@glendimplex.com.au](mailto:customer.care.ha@glendimplex.com.au)

#### **New Zealand**

Ph: 09 274 8265

[nztechserv@glendimplex.co.nz](mailto:nztechserv@glendimplex.co.nz)