

900mm stainless steel slide-out rangehood

Product Features

- Switch control
- Airflow 300m³/hr
- 2 Speed
- Ducted air operation
- 2X aluminium filters
- 2X 40 watt lamps
- Connection: 10amp



Fan speed

With 2 fan speeds you control the level of air you need to remove different levels of odours. For example, if cooking food with a strong odour like fish, the highest level of speed can be selected so odours are removed quickly.

Ducted

Ducted air operation allows for quicker odour removal as odours are directed to the exterior of your kitchen.

Superior extraction

Extraction rate allows for easy removal of odours, perfect for open plan living environments.

Design

This rangehood has been designed to compliment all of the cooking appliances in the Technika range.

900mm stainless steel slide-out rangehood

Recommended Clearances

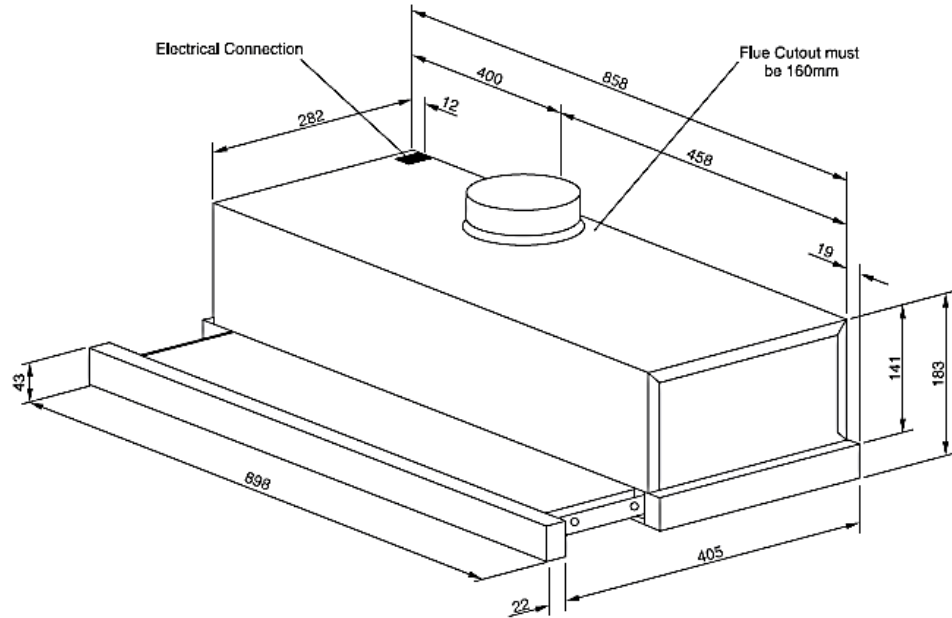
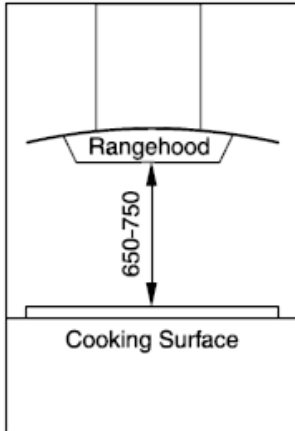

These dimensions are a guide only, please refer to product manual for up to date dimensions and product information

Dimensions	Width	Height	Depth
Cut-out (mm)	900	183	304
Product (mm)	898	183	282

Install Range Hoods in accordance with the manufacturer's instructions. Technika recommends that all Range Hood clearances be a minimum of 650mm to a maximum of 750mm (between the top of the cooking surface and to the underside of the rangehood).

Distance may be reduced to 600mm to align with the AGA code.

READ THE INSTRUCTION BOOKLET BEFORE INSTALLING AND USING THE APPLIANCE.

The manufacturer will not be responsible for any damage to property or to persons caused by incorrect installation or improper use of the appliance. The manufacturer is not responsible for any inaccuracies, due to printing or transcription errors, contained in this handout. In addition, the appearance of the figures reported is also purely indicative.

The manufacturer reserves the right to make changes to its products when considered necessary and useful, without affecting the essential safety and operating characteristics.

Technika constantly seeks ways to improve the specifications and designs of their products.

Whilst every effort is made to produce up to date literature, this document should not be regarded as an infallible guide.

Actual product only should be used to derive cut out sizes.

All Technika Appliances must be installed by a qualified person/s with adherence to the relevant electrical, plumbing and AGA codes, with compliance being issued as required by state or national legislation.

Additionally all Technika Upright cookers must have chains installed correctly in adherence to the relevant AGA, and plumbing codes by the Licenced installer.

For maximum effectiveness and efficiency all rangehoods should be installed with the use of ductwork, by a licenced installer with adherence to the relevant state and national building codes and regulations.

All Technika appliances are for Domestic use only, and must be installed by a licence installer into Domestic Applications only, without exception and to the required Authorities guidelines. Any installation outside of this will VOID warranty. Alfresco areas are not a Domestic application.