

TECHNIKA



Contents

For Your Safety	3
------------------------------	----------

Use and Care

Controls	6
Oven & Accessories	7
How to use your oven	8
Positioning the oven trays & shelves	9
Cooking modes	10
The oven light	12
Cooling ventilation	12
Digital clock timer with sensor touch control	12
Practical cooking advice	18
Cooking Guide	22
Cleaning and maintenance	24
How to remove the oven door	25
Replacing the oven lamp	26
Disposal	26

Installation

Cabinet Details	27
Electrical connection	29
Technical Data	30



For Your Safety

We recommend that you read the instructions in this owner's manual carefully before use for the best performance and to extend the life of your appliance. It will provide you with all the information you need to ensure its safe installation, use and maintenance. Retain this owner's manual for future reference.

When handling the appliance, we recommend you always use the handles recessed into the sides of the oven to prevent personal injury or damage to the appliance.

To maintain the efficiency and safety of this appliance, we recommend that you do the following:

- Always call the Technika service department if there are any faults with your appliance.
- Always use original spare parts available from Technika.
- This appliance is designed for non-commercial, household use and it must not be altered in any way.
- **This appliance can only be used safely when it is correctly connected to an efficient earthing system in compliance with current electrical safety standards.**
- **If the supply cord is damaged, it must be replaced by the manufacturer or its service agent or a similarly qualified person in order to avoid a hazard.**
- **During use, the appliance becomes hot. Care should be taken to avoid touching heating elements inside the oven. WARNING: Accessible parts will become hot when in use. To avoid burns and scalds, children should be kept away.**
- **The appliance is not intended for use by young children or infirm persons without supervision.**
- **Young children should be supervised to ensure that they do not play with the appliance.**
- **DO NOT use a steam cleaner to clean the appliance.**

Packaging items such as plastic bags, polystyrene, nails, etc. are potentially dangerous, and therefore appropriate measures must be taken to prevent children and the disabled from coming into contact with them.



For Your Safety

Avoid the following:

- Touching the appliance with wet parts of the body.
- Using the appliance while barefoot.
- Improper or dangerous operation.
- Obstructing the ventilation or heat dissipation slots.
- Allowing power supply cables of other appliances to come into contact with hot parts of the oven.
- Exposing the appliance to atmospheric agents such as rain, or direct sunlight.
- Using the oven for storage purposes.
- Using flammable liquids near the appliance.

Authorised personnel must be contracted to...

- Install the appliance according to these installation instructions and any local requirements.
- Replace the temperature probe if it is damaged. The probe is part of thermostat. Only use the temperature sensing probe recommended for this oven.

Technika Service Department must be contacted...

- If in doubt about the operation of the appliance.
- If in doubt about the soundness of the appliance after removing it from its packaging.
- If the power supply cable has been damaged or needs to be replaced.
- If the appliance requires a service.
- If you need spare parts.



For Your Safety

WARNINGS:

- **DO NOT** steam clean the oven.
- **Only** use the appliance to cook food and nothing else.
- Check that the appliance has not been damaged immediately after it has been unpacked.
- **Disconnect** the appliance from the electrical mains if it is not functioning properly and before cleaning or performing maintenance.
- Use oven gloves to place cookware in the oven or when removing it.
- Always grip the oven door handle in the centre.
- Make sure the knobs are in the 'O' or '●' position when the appliance is not in use.
- Techika will not accept any liability as a result of any damage due to incorrect installation or improper use.



Use and Care

Controls - Mechanical Timer

6 Function Model

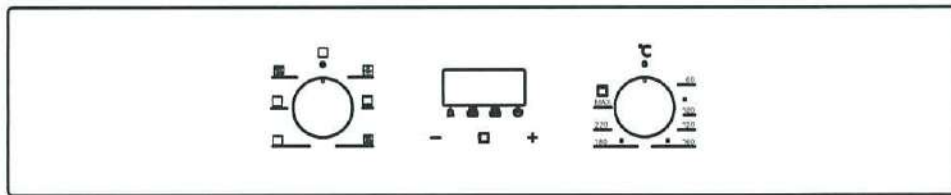



Use and Care

Oven & Accessories

Depending on which model you have, ovens are supplied with a side hinged or a bottom hinged door, chrome wire Shelf Supports or chrome wire/telescopic Shelf Supports and a range of shelf options as shown below. There are five shelf positions for all models, some models include two telescopic supports.



Use and Care

How to use your Oven

This multi-function oven combines the advantages of traditional convection ovens with modern fan assisted ovens in a single appliance. It is an extremely versatile appliance that allows you to choose easily and safely between different cooking modes. The various cooking modes are selected by means of a cooking mode selection knob, located on the control panel.

To operate the oven:

- Ensure that manual mode is selected (page 12)
- Turn the cooking mode selection knob to the desired cooking mode (explanation of cooking modes is on pages 10 to 11)
- Turn the cooking temperature selection knob to the desired temperature (cooking guide is on pages 17 to 18) or to **'MAX'** if Grilling.

The first time you use your appliance, we recommend that you set the thermostat to the highest setting, set the cooking mode selection knob to a cooking mode and leave the oven on for about half an hour with nothing in it and the oven door shut. Then, open the oven door and allow the oven to cool. Any odour that may be detected during this initial use is due to the evaporation of substances used to protect the oven during storage.

Note: Place the Baking Tray provided on the bottom shelf position of the oven to prevent any spillages from dripping onto the bottom of the oven. Never place anything on the bottom of the oven when it is in operation because this could damage the enamel. Only place your cookware (dishes, trays, aluminum foil, etc.) on the Oven Shelves provided with the appliance.



If supplied, use the chrome wire handle shown left when removing the trays from the oven.



Use and Care

Positioning the Oven Trays & Shelves

The Baking Tray, Grill Tray or Oven Shelf can be located in any of the five height positions in the oven if your oven does not have Telescopic Shelf Supports. Oven Shelves **cannot** be fitted to the Telescopic Support. **Only fit the Baking Tray or Grill Tray to the Telescopic Support.**

Refer to the 'Cooking Mode Table' for the recommended shelf position. When fitting the trays or shelves, ensure they are fitted between the two wires that are closest together as shown below. Oven Shelves have a stop so that they are not fully withdrawn by accident. To fully remove the Oven Shelves, lift the front of the shelf slightly and withdraw fully from the oven. Note that the Grill Tray and Baking Tray do not have a stop position and can be fully withdrawn without interruption, so be careful not to accidentally fully withdraw the trays.

Fit Trays and Shelves between bars as shown right

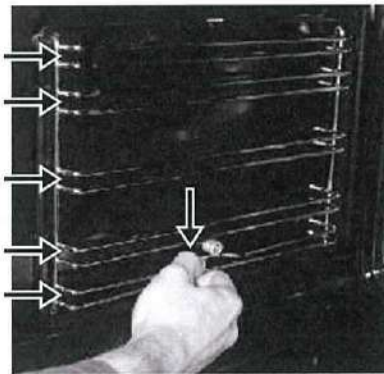

To remove the Oven Shelf Support, push down on the wire below the locking pin, pull away from the oven wall until you can release the top of the support from the holes in the oven wall. Replace in reverse procedure.



Oven Shelf fitted to chrome wire Shelf Support



Grill Tray fitted to Telescopic Shelf Support



Use and Care

COOKING MODES

Convection mode 2520W

When set to Convection mode, the top and bottom heating elements operate together like a 'normal' conventional oven that you have probably used before.

Convection mode is best suited for traditional baking and roasting and you should only use one shelf at a time, otherwise the heat distribution will be uneven. You can balance the amount of heat between the top and the bottom of the dish by selecting a different shelf height. If you want more heat at the top of the dish place the dish on the top or second shelf. For more heat at the bottom of the dish, place the dish on third or fourth shelf.

Grill mode 2520W

Select 'Grill' mode with cooking mode selection knob and turn cooking temperature selection knob to '**Max**'. When set to Grill mode, the top inner element operates. The extremely high and direct temperature of the grill makes it possible to brown the surface of meats and roasts while locking the juices in to keep them tender. Grill mode can also be used for dishes that require a high temperature on the surface such as beef steaks, veal, rib steak, filets, hamburgers, etc.

Grill food with the oven door **shut**.

Fan assisted grill mode 2550W

Select 'Fan Assisted Grill' mode with cooking mode selection knob and turn cooking temperature selection knob to the desired temperature setting. When set to Fan Assisted Grill mode, the top inner element and the fan operate. This mode increases the circulation of air throughout the oven, which helps prevent food from burning on the surface, allowing the heat to penetrate right into the food. Particularly suitable for kebabs made with meats and vegetables, sausages, ribs, lamb chops, chicken, quail, pork chops, fish steaks, stuffed cuttlefish etc.

In Fan Assisted Grill mode, grill with the oven door shut.



Use and Care

Delicate cooking mode 1460W

When set to Delicate cooking mode, the bottom element and the fan will operate. This mode is suitable for pastries, cakes and non-dry sweets in baking tins or moulds that require heat from the bottom.

Baking mode 2020W

When set to Baking mode, the fan element and the fan operate providing a delicate heat distributed uniformly throughout the oven.

This mode is ideal for baking and cooking delicate foods on multiple shelves, especially cakes that need to rise such as cream puffs and for certain tartlets, sweet or savoury biscuits, savoury puffs, swiss rolls and small portions of vegetables, etc.

Fast cooking mode 2560W

When set to Fast Cooking mode, the top and bottom heating elements, as well as the fan, will operate to provide a consistent heat distributed uniformly throughout the oven.

This mode is especially recommended for cooking pre-packed frozen foods or reheating cooked foods, where pre-heating is not necessary. For best results, use one cooking shelf at a time.

Top heat mode 1110W

When set to Top heat mode, the top heating element operates. This mode can be used to brown food at the end of cooking.

Defrost mode 55W

When set to 'Defrost' mode, the fan located at the back of the oven circulates room temperature air around the food. This is recommended for the defrosting of all types of food, but in particular for delicate types of food which do not require heat, for example: ice cream cakes, cream or custard desserts, fruit cakes, etc. By using 'Defrost' mode, the defrosting time is approximately halved. In the case of meat, fish and bread, it is possible to accelerate the process by selecting 'Multi Cooking mode' and setting the temperature between 80°C to 100°C.



Use and Care

The oven light

Set cooking mode selection knob to  symbol to switch on the oven light/s. The oven light/s stay on when the oven is operating.

Cooling ventilation

In order to cool down the exterior of the appliance, this model is equipped with a cooling fan, which switches on automatically. When the cooling fan is on, you will notice a flow of air exiting between the oven door and the control panel.

Note: When cooking is finished, the cooling fan continues to operate until the oven cools down and then switches off automatically.

Digital clock timer with sensor touch control

Touch control

Symbol 1 will start flashing when the unit is switched on for the first time. The symbols 12.00 appear on the display.

Setting the clock To set the current day time:

By pressing choice keys 2 or 3 (- or +) you can set the time.



After a few seconds the controller sets the time currently displayed and the symbol 1 goes out.

The set time can be also set afterwards. Therefore you have to: Press the middle key 4 repeatedly till the symbol 1 will start flashing. Set the time as described.



Important! If you change the time setting, you reset the timer and cancel former set programs.



Use and Care

Electronical countdown timer

The countdown timer works independently of all other timer functions, and can be used even when the oven is switched off.

To switch on the countdown timer Press the middle key 1 repeatedly till the symbol 2 will start flashing. The symbols 0.00 appear on the display.

Press the choice keys 3 or 4 (- or +) to

set the duration and wait a few seconds. After a few seconds the timer starts the countdown, the display shows the countdown time, the symbol countdown timer 2 appears. By pressing the button 1 you can call up the current time indication for 5 seconds.

After the end of the countdown the oven emits the double sound signals with interval of 2 seconds during two minutes. The symbol countdown timer 2 will continue to flash after the end of emitting the sound signals.

Press any key to turn off the sound signals and the symbol countdown timer 2.

The symbol countdown timer 2 goes out. The display shows the current time.





Use and Care

Setting the cooking time

①、 The process in the oven should switch off after a wanted duration automatically (only for function electric grill).

Before setting the duration you have to set the oven operating function grill and the temperature (see chapter "Electric grill").

Press the middle key 1 repeatedly till the symbol 2 will start flashing. The symbols 0.00 appear on the display.

By using the choose keys 3 or 4 (- or +) you set the wanted duration of the preparation. After a few seconds the countdown of the duration starts.

The display shows the countdown time, symbol 2 appears on the display to confirm the successful setting and the current time appears again.

After the end of the countdown the oven emits the triple sound signals with the interval of 2 seconds during two minutes to inform you that all processes in the oven are switched off. The symbol 2 will continue to flash after the end of emitting the sound signals.

Turn the rotary handles of oven operating functions and of temperature regulator in the zero position.

Press any key to turn off the timer and the sound signals. The symbol 2 goes out. The display shows the current time.

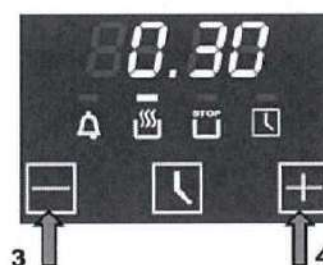

Attention! If you don't turn the rotary handles in the zero position after the switch off of the timer, the oven will continue to operate.



Use and Care

②、 The oven must switch off after the set end time (only for function electric grill). Before setting the end of cooking time you have to set the oven operating function grill and the temperature (see chapter "Electric grill").

Press the middle key 1 repeatedly till the symbol 2 will start flashing.

The symbols 0.00 appear on the display.

By using the choose keys 3 or 4 (- or +) you set the wanted end of the preparation. After a few seconds the program is activated. The display shows the countdown time, symbol 2 appears on the display to confirm the successful setting and the current time appears again.

After the set end time is reached a fourfold tone with the interval of 2 seconds sounds and the symbols flash to inform you that all processes in the oven are switched off.

Turn the rotary handles of oven operating functions and of temperature regulator in the zero position.

Press any key to turn off the timer and the sound signals.

The symbol 2 goes out. The display shows the current time.

Important! You should set a time that differs from the current day time.

Attention! If you don't turn the rotary handles in the zero position after the switch off of the timer, the oven will continue to operate.





Use and Care

Setting cooking duration and end times

You can combine the cooking duration and end of cooking time functions to set the start and end times for cooking. In this way you can program your electronic oven to cook while you are out (only for function electric grill). A great help in the kitchen!

Set first the duration 1 and then the end of cooking time 2.

Example: You want to start cooking a dish 30 minutes before you get home so that it will be ready for you arrival at 12:55.

Before you set the duration and the end of cooking time, you have to set the oven operating function grill 3 and the temperature (see chapter "Electric grill").

Set the cooking duration 4 (in our example – 30minutes).

Therefor you have to program the wanted end of cooking time (see chapter «Setting cooking duration»).

The symbol 5 appears on the display, that confirms a successful programming of the cooking duration and the current day time appears again.





Use and Care

Now set the wanted end time (see chapter «Setting the end time»).

The end time (1) appears on the display, that accords to the current day time plus duration (in our example 12:45, that means plus 30 minutes).



Set the wanted end time with the choice key 2 (+).

A few seconds later this time will be registered 3 (in our example – 12:55, that means we shifted the end time 10 minutes).



The oven is in expectance state now. The current day time is displayed 4 (in our example 12:15).



In our example the oven should be turned on at 12:25 (5) with the functions "Grill + Thermocirculation" and be turned off at 12:55 according to your setting.



Attention! If you don't turn the rotary handles in the zero position after the switch off of the timer, the oven will continue to operate.





Use and Care

PRACTICAL COOKING ADVICE

The oven offers a wide range of settings which allow you to cook any type of food in the best possible way. With time you will learn to make the best use of this versatile cooking appliance and the following directions are only a guideline which may be varied according to your own personal experience.

Preheating

If the oven needs to be preheated, the 'Convection' mode  or 'Baking' mode  should be selected. These are the most efficient modes, which will reach the desired temperature as quickly as possible using the least amount of energy.

Once the food has been placed in the oven, the desired cooking mode should then be selected.

Multi shelf cooking

If you want to cook food on several shelves, select the 'Baking' mode  as this is the only cooking mode that allows you to do so.

When cooking delicate foods on more than one shelf, use the 'Baking' mode. This mode allows you to cook on 3 shelves at the same time. Refer to the 'Cooking Guide' table.



Use and Care

Using the Grill

This multi-function oven has 2 different grilling modes.

Use the 'Grill' mode  with the oven door **shut**, place the food on the centre of the grill pan, insert and fit the grill pan on either the 3rd or 4th shelf from the bottom. Note: only the central part of the top heating element operates for grilling.

When using 'Grill' mode, we recommend you set the thermostat to the highest setting. However, this does not mean you cannot use lower temperatures, simply adjust the thermostat knob to the desired temperature.

Use 'Fan assisted grill' mode  with the oven door **shut**. This mode is very useful for grilling foods rapidly, as the distribution of heat by the fan makes it possible not only to brown the surface, but also to cook the bottom of the food. It can also be used for browning foods at the end of the cooking process, such as adding that gratin finish to pasta bakes for example.

When using 'Fan assisted grill' mode, place the food on the 2nd or 3rd oven shelf from the bottom, then place a dripping-pan on the 1st rack from the bottom to prevent fat and grease from dripping onto the oven floor. We recommend you set the thermostat to 200°C, as it is the most efficient temperature for 'Fan assisted grill' mode. However, this does not mean you cannot use lower temperatures, simply adjust the thermostat knob to the desired temperature.

Important: for best results and to save energy, always use the 'Fan assisted grill' with the oven door **shut**.



Use and Care

Baking Cakes

When baking cakes, always place them in a preheated oven. Make sure you wait until the oven has been preheated thoroughly (the indicator light will turn off). To prevent heat loss and the cake from dropping, do not open the oven door during baking.

In general...

... if pastry is too dry

Increase the temperature by 10°C and reduce the cooking time.

... if pastry has dropped

Use less liquid or lower the temperature by 10°C.

... if pastry is too dark on top

Place it on a lower shelf, lower the temperature, and increase the cooking time.

... if cooked well on the inside but sticky on the outside

Use less liquid, lower the temperature, and increase the cooking time.

... if the pastry sticks to the pan

Grease the pan well and sprinkle it with a dusting of flour or use greaseproof paper.



... if I used multi shelf cooking and one shelf is more cooked

Use a lower temperature setting next time. It is not necessary to remove the food from all the racks at the same time.



Use and Care

Cooking Pizza

For best results when cooking pizza, use the 'Convection' mode  or 'Baking' mode .

- Preheat the oven for at least 10 minutes.
- Use a light aluminum pizza pan, placing it on the shelf supplied with the oven. Don't use the dripping pan since this will extend the cooking time, making it difficult to get a crispy crust.
- Do not open the oven door frequently while the pizza is cooking;
- If the pizza has a lot of toppings (three or four), we recommend you add the mozzarella cheese on top halfway through the cooking process.
- For best results, only use one shelf at a time, but if you want to cook on two shelves, use the 2nd and 4th racks from the bottom with a temperature of 220°C and swap them halfway through cooking.

Cooking Fish and Meat

When cooking white meat, fowl and fish, use a temperature setting from 180°C to 200°C.

For red meat that you want well done on the outside while tender and juicy in the inside, it is best to start with a high temperature setting (200°C-220°C) for a short time, then turn the oven down afterwards.





In general, the larger the roast, the lower the temperature setting. Place the meat on the centre of the shelf and place the dripping pan beneath it to catch the fat.

Make sure that the shelf is inserted so that it is in the centre of the oven. If you would like to increase the amount of heat from below, use a lower shelf height. For savoury roasts (especially duck and wild game), dress the meat with lard or bacon on the top.



Use and Care



Cooking Guide

Food to be cooked	Weight (in kg)	Cooking rack position from bottom	Preheating time (Minutes)	Thermostat knob setting	Cooking time (Minutes)
 Convection					
Duck	1	3	15	200	65-75
Roast veal or beef	1	3	15	200	70-75
Pork roast	1	3	15	200	70-80
Biscuits (short pastry)	-	3	15	180	15-20
Tarts	1	3	15	180	30-35
 Top Oven					
Browning food to perfect Cooking	-	3/4	15	220	-
 Defrosting					
All frozen food					
 Grill					
Soles and cuttlefish	1	4	5	Max	8-10
Squid and prawn kebabs	1	4	5	Max	6-8
Cod filet	1	4	5	Max	10
Grilled vegetables	1	3/4	5	Max	10-15
Veal steal	1	4	5	Max	15-20
Cutlets	1	4	5	Max	15-20
Hamburgers	1	4	5	Max	7-10
Mackerels	1	4	5	Max	15-20
Toasted sandwiches	-	4	5	Max	2-3
With rotisserie (where present)					
Veal on the spit	1.0	-	5	Max	80-90
Chicken on the spit	1.5	-	5	Max	70-80
Lamb on the spit	1.0	-	5	Max	70-80
 Fan Assisted Grill					
Grilled chicken	1.5	3	5	200	55-60
Cuttlefish	1.5	3	5	200	30-35
With rotisserie (where present)					
Veal on the spit	1.5	-	5	200	70-80
Chicken on the spit	2.0	-	5	200	70-80
Chicken (on the spit)+potatoes (roasted)	1.5	-	5	200	70-75
	-	2	5	200	70-75
Lamb on the spit	1.5	-	5	200	70-80



Use and Care

Cooking Guide (cont'd)

Food to be cooked	Weight (in kg)	Cooking rack position from bottom	Preheating time (Minutes)	Thermostat knob setting	Cooking time (Minutes)
 Fast cooking					
Frozen food					
Pizza	0.3	2	-	250	12
Courgette and prawn pie	0.4	2	-	200	20
Country style spinach pie	0.5	2	-	220	30-35
Turnovers	0.3	2	-	200	25
Lasagne	0.5	2	-	200	35
Golden Rolls	0.4	2	-	180	25-30
Chicken morseis	0.4	2	-	220	15-20
Pre-cooked food					
Golden chicken wings	0.4	2	-	200	20-25
Fresh Food					
Biscuits(short pastry)	0.3	2	-	200	15-18
Fruitcake	0.6	2	-	180	45
Cheese puffs	0.2	2	-	210	10-12
 Baking					
Tarts	0.5	3	15	180	20-30
Fruit cakes	1	2/3	15	180	40-45
Fruitcake	0.7	3	15	180	40-50
Sponge cake	0.5	3	15	160	25-30
Stuffed pancakes (on 2 shelves)	1.2	2-4	15	200	30-35
Small cakes (on 2 shelves)	0.6	2-4	15	190	20-25
Cheese puffs (on 2 shelves)	0.4	2-4	15	210	15-20
Cream puffs (on 3 shelves)	0.7	1-3-5	15	180	20-25
Biscuits (on 3 shelves)	0.7	1-3-5	15	180	20-25
Meringues (on 3 shelves)	0.5	1-3-5	15	90	180

Note: Cooking times are approximate and may vary according to personal taste. When cooking using the grill or fan assisted grill, the dripping pan must always be placed on the 1st oven shelf from the bottom.



Use and Care

Cleaning and Maintenance

Before cleaning your oven or performing maintenance, make sure that the cooking mode selection knob is set to 'OFF' symbol and the cooking temperature selection knob is set to 'OFF'. To extend the life of your oven, it must be cleaned frequently.

The enamelled or stainless steel parts should be washed with lukewarm water without using any abrasive powders or corrosive substances. Spray on surface cleaners should also be avoided. The use of these cleaners can result in the development of rust and corrosion. If any stainless steel has difficult to remove stains, use cleaners specifically recommended to clean stainless steel. After cleaning any surface, it is advisable to rinse thoroughly and dry. The inside of the oven should preferably be cleaned immediately after use, when it is still warm (but not hot), with warm water and soap. The soap should be rinsed away and the interior dried thoroughly. Avoid using abrasive detergents, scourers acidic cleaners such as lime scale remover, etc. as these could damage the enamel. also can result in the development of rust and corrosion. If stains are particularly tough to remove, use cleaners specifically recommended to clean ovens and follow the instructions provided with the cleaner.

Never use a steam cleaner for cleaning inside the oven.

If you operate your oven for an extended period of time, or if you are cooking dishes that contain a lot of water, condensation may form on the oven door. Dry it using a soft cloth and try reducing the cooking temperature.

There is a rubber seal surrounding the oven opening which is necessary to ensure the correct operation of the oven. Check the condition of this seal on a regular basis. If necessary, clean it but avoid using abrasive products or objects to do so. Should it become damaged, please contact Technika Service Department. We recommend you avoid using the oven until it has been repaired.

Never line the oven bottom with aluminum foil as the accumulation of heat could compromise the cooking process and even damage the enamel.

Clean the glass door using non-abrasive products or sponges and dry it with a soft cloth.



Use and Care

How to Remove the Oven door

For a more thorough clean, you can remove the oven door. Choose the remove and assemble method According to different structure of oven door purchased. Proceed as follows:

Oven door structure 1 remove and assemble procedure:

1. Open the door fully ;
2. Lift up and turn the small levers situated on the two hinges ;
3. Grip the door on the two external sides ,shut it slowly but not Completely;
4. Pull the door towards you ,pulling it out of its seat ;
5. Reassemble the door by following the above procedures backwards.

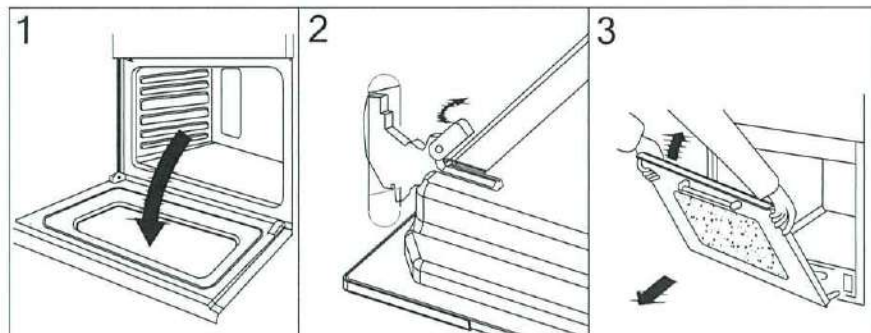



Use and Care

Replacing the Oven Lamp

WARNING: Ensure that the appliance is switched off before replacing the lamp to avoid the possibility of electric shock.

Remove the glass cover of the lamp-holder as shown below.

Remove the lamp and replace with a lamp resistant to high temperatures (300°C) with the following characteristics:

- Voltage: 240V
- Wattage: 25W
- Type: E 14

Replacement lamps are available from Technika. Replace the glass cover and reconnect the oven to the mains power supply.

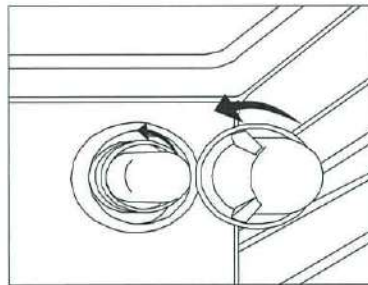

All electrical connections must be performed by an electrically licensed contractor.

All care must be taken to ensure the installation is properly earthed and conforms to local codes.

- The oven must be installed in a heat resistant cabinet withstanding temperatures of no less than 75°C. Where low temperature cabinetry is bordering the appliance, a 16mm clearance must be provided between the oven and the doors or drawers.
- The oven must have a 50mm clearance below the benchtop or cooktop.
- A cutout of 380mm x 380mm in the cavity base (below the oven) is needed for ventilation.

Drawers underneath the oven are not recommended.

- This oven must be completely sealed from adjacent cabinets to prevent condensation.
- The oven must be secured by 4 screws to the cabinet.
- The oven must be connected to 15 amp circuit.
- Technika will not be held responsible for damages to cabinetry due to incorrect installation



Use and Care

Disposal

By ensuring this product is disposed of correctly, you will help prevent potential negative consequences for the environment and human health, which could otherwise be caused by inappropriate waste handling of this product.



The symbol on the product indicates that this product may not be treated as household waste. Instead it shall be handed over to the applicable collection point for the recycling of electrical and electronic equipment.

Disposal must be carried out in accordance with local environmental regulations for waste disposal.

For more detailed information about treatment, recovery and recycling of this product, please contact your local city council office.



Installation

IMPORTANT: Installation, assembly and electrical connections must be carried out by authorised personnel.

Cabinet Details

In order to ensure that the built-in appliance functions properly, the cabinet containing it must be appropriate. The figure below gives the dimensions of the cut-out for installation under the counter or in a wall cabinet unit.

Flush Fit

Technika recommends that our 600mm electric ovens be installed as flush fit only

* Ventilation: provide cut out at rear for wall oven installation only 90mm x 400mm

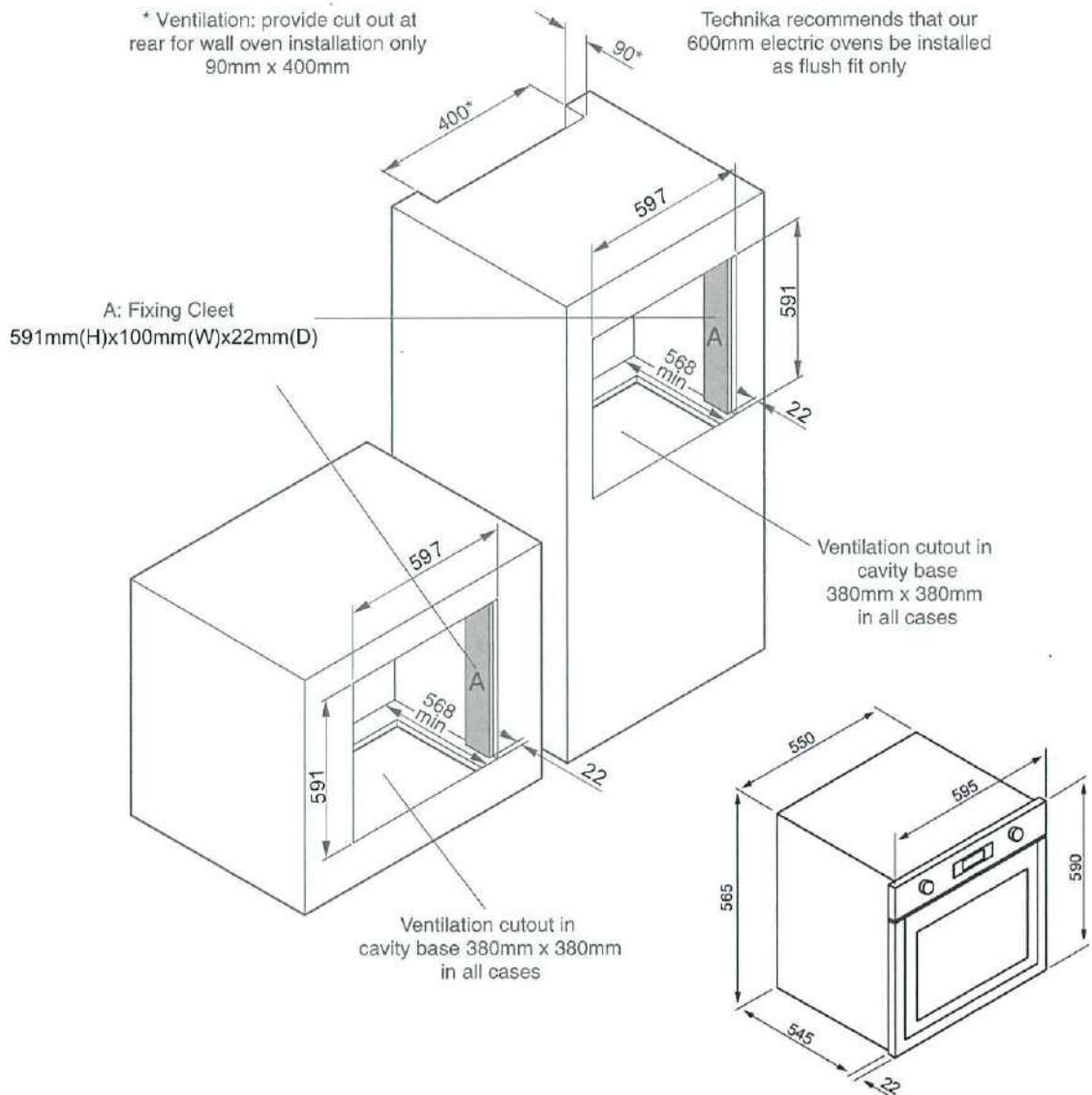



Installation

- All electrical connections must be performed by a licensed contractor
- All care must be taken to ensure the installation is properly earthed and conforms to local codes
- The oven must be installed in a heat resistant cabinet withstanding temperatures of no less than 75 C
- For low temperature cabinetry a 16mm clearance must be provided between the oven and the doors or drawers
- The oven requires a 50mm clearance from the benchtop or cooktop
- The cabinet must be completely sealed from other and adjacent cabinets to prevent condensation
- The oven must be secured by 4 screws to the cabinet
- The oven must be connected to a 16amp circuit
- The oven requires a ventilation cut out to allow proper air circulation, see installation sheet
- Technika will not be held responsible for damages to cabinetry due to incorrect installation



Installation

Electrical Connection

Fit a plug that is appropriately rated for the load indicated on the data plate to the cable supplied with the appliance. The plug must be compatible with the socket outlet fitted to the final sub-circuit in the fixed wiring that is intended to supply this appliance.

If connecting the cable directly to the mains, install a suitable isolating switch with a minimum contact opening of 3mm between the appliance and the mains. The isolating switch should be sized according to the load on the data label and should comply with current regulations (the earth wire should not be interrupted by the circuit breaker).

Connection to the electricity supply must be made by an authorised person in accordance with the Wiring Rules AS/NZS3000.

The supply cable should be positioned so that it does not reach a temperature of more than 75°C.



Installation

Technical Data

Inner dimensions of the oven:

Width: 43.5cm

Depth: 40cm

Height: 32cm

Inner Volume of the oven: 56 litres.

Voltage and Frequency of Power Supply:

240V ~ 50Hz

Power Usage:



2520W



2520W



2550W



2020W



2560W



1460W



1110W



55W

TECHNIKA
TOMORROWS TECHNOLOGY TODAY

TECHNIKA PTY LTD ACN 069 686 326
77 Fillo Drive Somerton Victoria 3062
General : 1800 649 969 - Service : 1800 333 244

Technika After Sales Service - P.O. Box 543 SOMERTON VIC 3061

Version 2 - Revision 20120830