

**GDW14S-2**  
60cm Freestanding Dishwasher

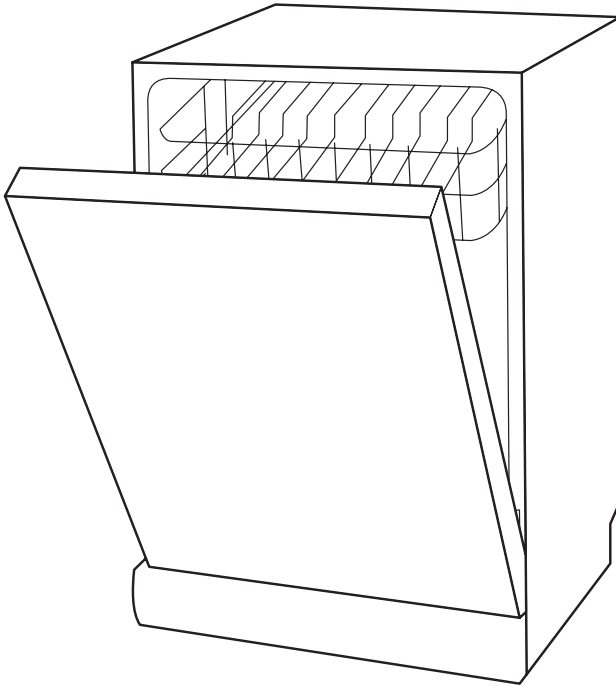

**USER MANUAL**

# THANK YOU FOR YOUR PURCHASE

Dear Customer,

Congratulations on the purchase of your new product from **Glen Dimplex**.

We recommend you please take some time to read the instruction manual thoroughly to familiarise yourself with the functionality and operations to ensure optimum performance of your new appliance.

After reading the manual, please store it in a safe and accessible location for future reference.

## **Installation**

The installation of your new appliance must be carried out by a qualified installer / technician in accordance to local regulations. Please ensure all packaging materials are disposed of correctly.

## **Customer Care**

Our Customer Care centre is available should you wish to learn more about your appliance in relation to how to use it to its best potential, or tips on cleaning as well as available accessories.

## **For Further Details Please Contact Our Customer Care Team**

---

Glen Dimplex Australia Pty Ltd

Ph: 1300 556 816

[customer.care.ha@glendimplex.com.au](mailto:customer.care.ha@glendimplex.com.au)

[www.glendimplex.com.au](http://www.glendimplex.com.au)

Glen Dimplex New Zealand Ltd

Ph: 09 274 8265

[nztechserv@glendimplex.co.nz](mailto:nztechserv@glendimplex.co.nz)

[www.glendimplex.co.nz](http://www.glendimplex.co.nz)

Thank you.

Regards,

Glen Dimplex Australia

# CONTENTS

<u>Before You Begin</u>	<u>4</u>	<u>Operation (Continued)</u>	<u>12</u>
<u>Explanation of Symbols</u>	<u>4</u>	<u>Basket Use and Tips</u>	<u>18</u>
<u>For Your Safety</u>	<u>5</u>	<u>Upper Basket: Top View</u>	<u>19</u>
<u>General Safety</u>	<u>5</u>	<u>Lower Basket: Top View</u>	<u>19</u>
<u>Electrical Safety</u>	<u>5</u>	<u>Cutlery Tray and Basket: Top View</u>	<u>20</u>
<u>Product Safety</u>	<u>6</u>	<u>Preparing and Loading Dishes</u>	<u>21</u>
<u>Intended Use</u>	<u>7</u>	<u>Programming the Dishwasher: Wash Cycle Table</u>	<u>23</u>
<u>Child Safety</u>	<u>7</u>	<u>Starting a Wash Cycle</u>	<u>24</u>
<u>Disposal Regulations</u>	<u>7</u>	<u>Changing the Program Mid-Cycle</u>	<u>24</u>
<u>Installation</u>	<u>8</u>	<u>Adding a Dish During a Cycle</u>	<u>24</u>
<u>Electrical Requirements</u>	<u>8</u>	<u>Maintenance &amp; Cleaning</u>	<u>25</u>
<u>Electrical Connection</u>	<u>8</u>	<u>External Care</u>	<u>25</u>
<u>Positioning and Levelling the Appliance</u>	<u>9</u>	<u>Internal Care</u>	<u>25</u>
<u>Freestanding Installation</u>	<u>10</u>	<u>Caring for the Dishwasher</u>	<u>27</u>
<u>Water Supply and Drain</u>	<u>10</u>	<u>Trouble Shooting</u>	<u>28</u>
<u>Connection of Drain Hoses</u>	<u>11</u>	<u>Before Calling for Service</u>	<u>28</u>
<u>Operation</u>	<u>12</u>	<u>Error Codes</u>	<u>31</u>
<u>Dishwasher and Accessory Overview</u>	<u>12</u>	<u>Technical Specifications</u>	<u>32</u>
<u>Control Panel Overview</u>	<u>13</u>	<u>Product Dimension</u>	<u>32</u>
<u>How To Use the Control Panel</u>	<u>14</u>	<u>Product Fiche</u>	<u>33</u>
<u>Understanding the Programs and Indicators</u>	<u>15</u>	<u>Manufacturers Guarantee</u>	<u>34</u>
<u>Function of Rinse Aid and Detergent</u>	<u>15</u>		
<u>Filling the Rinse Aid Reservoir</u>	<u>16</u>		
<u>Adjusting the Rinse Aid Reservoir</u>	<u>16</u>		
<u>Filling the Detergent Dispenser</u>	<u>17</u>		





# BEFORE YOU BEGIN

Please read the user manual carefully before using the unit.

## Explanation of Symbols

---

Throughout this user manual the following symbols are used:

Icon	Type	Meaning
	Warning / Caution	Serious injury or death risk
	Risk of electric shock	Dangerous voltage risk
	Fire hazard	Warning; risk of fire / flammable materials
	Hot surface	Warning; risk of injury from touching a hot surface
	Important / Note	Important information or useful hints about usage

This section contains safety instructions that will help protect from risk of personal injury or property damage. Failure to follow these instructions shall void any warranty.

## General Safety











---

- This appliance is not intended for use by persons (including children) with reduced physical, sensory or mental capabilities, or lack of experience and knowledge, unless they have been given supervision or instruction concerning use of the appliance by a person responsible for their safety.
- Children should be kept away unless continuously supervised.
- Adjustable feet should not be removed. The gap between the dishwasher and the floor should not be reduced with materials such as carpet, wood and tape. This will cause problems with the dishwasher.
- Always have the installation and repairing procedures carried out by the Authorized Service. Manufacturer shall not be held liable for damages that may arise from procedures carried out by unauthorized persons.

 Never clean the dishwasher by spraying or pouring water onto it! There is the risk of electric shock!

## Electrical Safety

---

-  Electrical safety instructions should be followed while electrical connection is made during the installation.
-  The appliance must not be supplied through an external switching device, such as a timer, or connected to a circuit that is regularly switched on and off by utility.
-  This appliance must be earthed. In the event of a malfunction or breakdown, earthing will reduce the risk of an electric shock by providing a path of least resistance of electric current. This appliance is equipped with an earthing conductor plug.
-  Improper connection of the equipment-earthing conductor can result in the risk of an electric shock.
-  Do not touch the plug with wet hands!  
Never unplug by pulling on the cable, always pull out by grabbing the plug.
-  Do not use extension cords, multi-plugs or adaptors to connect the dishwasher
-  to power supply in order to decrease the risk of fire and electric shock.
-  To protect against the risk of electrical shock, do not immerse the unit, cord or plug in water or other liquid.
-  If the supply cord is damaged, it must be replaced by the manufacturer or an authorised service agent or similarly qualified persons in order to avoid a hazard.
-  If the dishwasher is faulty, it must not be operated unless it is repaired by an authorized service agent! There is the risk of electric shock!

# FOR YOUR SAFETY

## Electrical Safety *(Continued)*

---

- The plug must be plugged into an appropriate outlet that is installed and earthed in accordance with all local codes and ordinances.
- Check with a qualified electrician or service representative if you are in doubt whether the appliance is properly grounded.
- Do not modify the plug provided with the appliance; if it does not fit the outlet, have a proper outlet installed by a qualified electrician.
- Unplug the dishwasher from the mains during installation, maintenance, cleaning and repair works. Power cable plug must be easily accessible after installation.

## Product Safety

---

- ⚠ Do not place any heavy objects on or stand on the door when it is open. The appliance could tip forward.
  - ⚠ Some dishwasher detergents are strongly alkaline. They can be extremely dangerous if swallowed. Avoid contact with the skin and eyes and keep children away from the dishwasher when the door is open.
  - ⚠ The door should not be left open, since this could increase the risk of tripping.
  - ⚠ If the supply cord is damaged, it must be replaced by the manufacturer or its service agent or a similarly qualified person in order to avoid a hazard.
  - ⚠ During installation, the power supply must not be excessively or dangerously bent or flattened.
- Do not abuse, sit on, or stand on the door or dish rack of the dishwasher.
  - Do not operate your dishwasher unless all enclosure panels are properly in place.
  - Open the door very carefully if the dishwasher is operating, there is a risk of water squirting out.
  - When loading items to be washed:
    - a) Locate sharp items so that they are not likely to damage the door seal;
    - b) Warning: Knives and other utensils with sharp points must be loaded in the basket with their points facing down or placed in a horizontal position.
  - Check that the detergent powder is empty after completion of the wash cycle.
  - Do not wash plastic items unless they are marked "dishwasher safe" or the equivalent.
  - For unmarked plastic items not so marked, check the manufacturer's recommendations.
  - Use only detergent and rinse agents recommended for use in an automatic dishwasher.
  - Never use soap, laundry detergent, or hand washing detergent in your dishwasher.
  - Do not tamper with controls.
  - The appliance needs to be connected to the main water valve using new hose sets. Old sets should not be reused.
  - To save energy, in stand by mode, the appliance will switch off automatically while there is no any operation in 30 minutes.

## Product Safety *(Continued)*

---

- When cleaning use a soft cloth moistened with mild soap, and then use a dry cloth to wipe it again.
- Any openings in the base must not be obstructed by carpet.

## Intended Use

---

- Dishwasher has been designed for domestic use. It is not suitable for commercial use and it must not be used out of its intended use.
- Use the dishwasher only for washing items that are marked accordingly.
- The manufacturer waives any responsibility arisen from incorrect usage or transportation.
- This appliance is intended to be used in household and similar applications such as:
  - a) staff kitchen areas in shops, offices and other working environments;
  - b) farm houses;
  - c) by clients in hotels, motels and other residential type environments;
  - d) bed and breakfast type environments.

## Child Safety

---

- Packaging materials are dangerous for the children. Keep packaging materials away from children.
- Electrical products are dangerous for the children. Keep children away from the product when it is operating. Do not let them tamper with the dishwasher. Use the child-proof lock in order to prevent the children to tamper with the dishwasher.

 Child-proof lock is on the control panel. (See Child lock)

- Keep loading door closed even when the dishwasher is not in use.

## Disposal Regulations

---



This product has been manufactured with high quality parts and materials which can be reused and are suitable for recycling. Do not dispose of the waste product with normal domestic and other wastes at the end of its service life. Take it to the collection center for the recycling of electrical and electronic equipment. Please consult your local authorities to learn about these collection centers.

- Cardboard packaging is manufactured from recycled paper and should be disposed in the waste paper collection for recycling.
- By ensuring this product is disposed of correctly, you will help prevent potential negative consequences for the environment and human health, which could otherwise be caused by inappropriate waste handling of this product.
- For more detailed information about recycling of this product, please contact your local city office and your household waste disposal service.

# INSTALLATION

Before calling the nearest authorized service agent for the installation of the dishwasher, ensure that electrical installation and water drain is appropriate referring to the user's manual. If they are not suitable, contact a qualified electrician and technician to make necessary arrangements.

- ① Installation of the water pipes and electrical connection must be carried out by a qualified professional.
- ⚠ Prior to installation, visually check if the dishwasher has any defects on it. If the dishwasher is damaged, do not have it installed. Damaged products cause risks for your safety.
- ⚠ Disconnect electrical power before installing the dishwasher. Failure to do so could result in death or electric shock.

## Electrical Requirements

---

- ⚠ For personal safety: Do not use an extension cord or an adapter plug with this appliance. Do not, under any circumstances, cut or remove the earthing connection from the power cord.
- Please look at the rating label to know the rating voltage and connect the dishwasher to the appropriate power supply. Use the required fuse 10A, time delay fuse or circuit breaker recommended and provide separate circuit serving only this appliance.

## Electrical Connection

---

Ensure the voltage and frequency of the power being corresponds to those on the rating plate. Only insert the plug into an electrical socket which is earthed properly. If the electrical socket to which the appliance must be connected is not appropriate for the plug, replace the socket, rather than using a adaptors or the like as they could cause overheating and burns.

- ⚠ Ensure that proper earthing exists before use.



## Positioning and Levelling the Appliance

---

Position the appliance in the desired location. The back should rest against the wall behind it, and the sides, along the adjacent cabinets or walls. The dishwasher is equipped with water supply and drain hoses that can be positioned either to the right or the left sides to facilitate proper installation.

Once the appliance is positioned for levelling, the height of the dishwasher may be altered via adjustment of the screwing level of the feet. In any case, the appliance should not be inclined more than 2°.

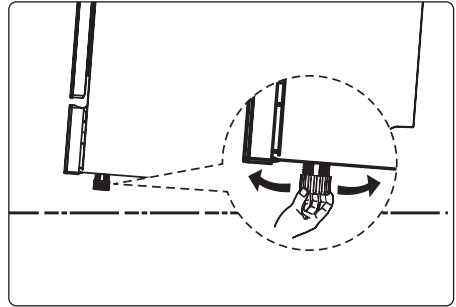

# INSTALLATION

## Freestanding Installation

### Fitting between existing cabinets

The height of the dishwasher, 845 mm, has been designed in order to allow the machine to be fitted between existing cabinets of the same height in modern fitted kitchens. The feet can be adjusted so that correct height is reached. The laminated top of the machine does not require any particular care since it is heatproof, scratchproof and stainproof.



### Fitting beneath / underneath an existing benchtop

In most modern fitted kitchens there is only one single work top under which cabinets and electrical appliances are fitted. In this case remove the work top of the dishwasher by unscrewing the screws under the rear edge of the top (a).

⚠ After removing the work top, the screws must be screwed again under the rear edge of the top (b).

ⓘ The height will then be reduced to 815 mm, as scheduled by the International Regulations (ISO) and the dishwasher will fit perfectly under the kitchen working top.

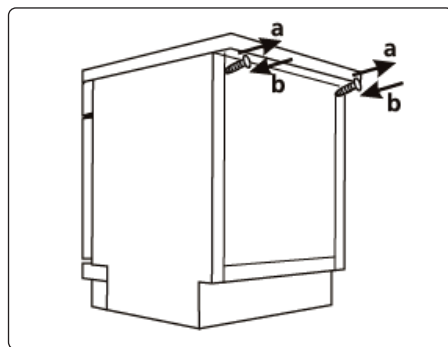

## Water Supply and Drain

### Cold water connection

- Connect the cold water supply hose to a threaded  $\frac{3}{4}$ (inch) connector and make sure that it is fastened tightly in place.
- If the water pipes are new or have not been used for an extended period of time, let the water run to make sure that the water is clear. This precaution is needed to avoid the risk of the water inlet to be blocked and damage the appliance.

ⓘ Close the hydrant after using.

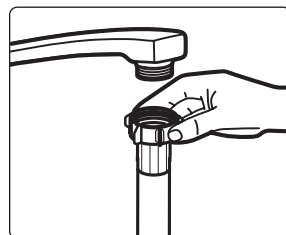

## Connection of Drain Hoses

Insert the drain hose into a drain pipe with a minimum diameter of 4 cm, or let it run into the sink, making sure to avoid bending or crimping it. The height of drain pipe must be less than 1000mm. The free end of the hose must not be immersed in water to avoid the back flow of it.

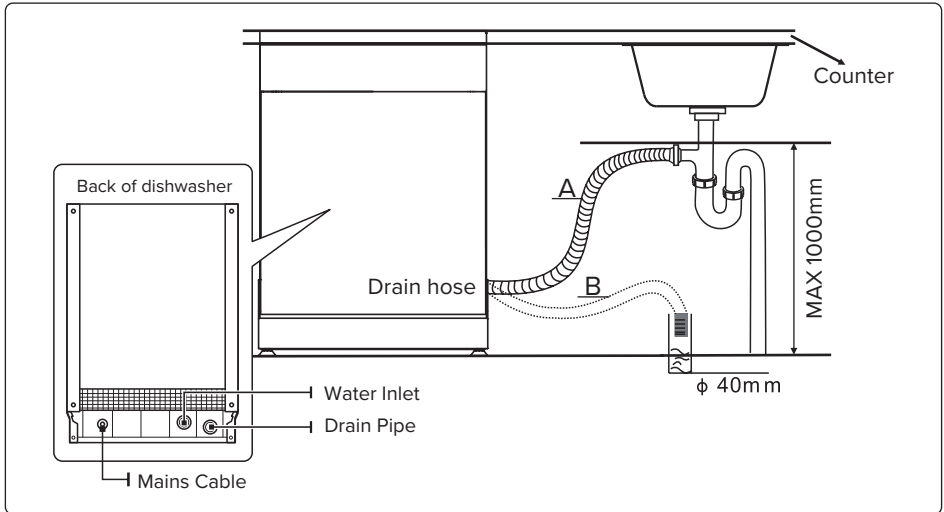

**▲ Securely fix the drain hose in either position A or position B.**

### How to drain excess water from hoses

If the sink is 1000 higher from the floor, the excess water in hoses cannot be drained directly into the sink. It will be necessary to drain excess water from hoses into a bowl or suitable container that is held outside and lower than the sink.

### Water outlet

Connect the water drain hose. The drain hose must be correctly fitted to avoid water leaks. Ensure that the water drain hose is not kinked or squashed.

### Extension hose

If you need a drain hose extension, make sure to use a similar drain hose. It must be no longer than 4 meters; otherwise the cleaning effect of the dishwasher could be reduced.

### Syphon connection

The waste connection must be at a height less than 100 cm (maximum) from the bottom of the dish. The water drain hose should be fixed.

# OPERATION

## Dishwasher & Accessory Overview

---

1. Inner pipe
2. Lower spray arm
3. Filter assembly
4. Dispenser
5. Upper basket
6. Cup rack
7. Cutlery rack
8. Cutlery basket
9. Upper spray arm
10. Lower basket

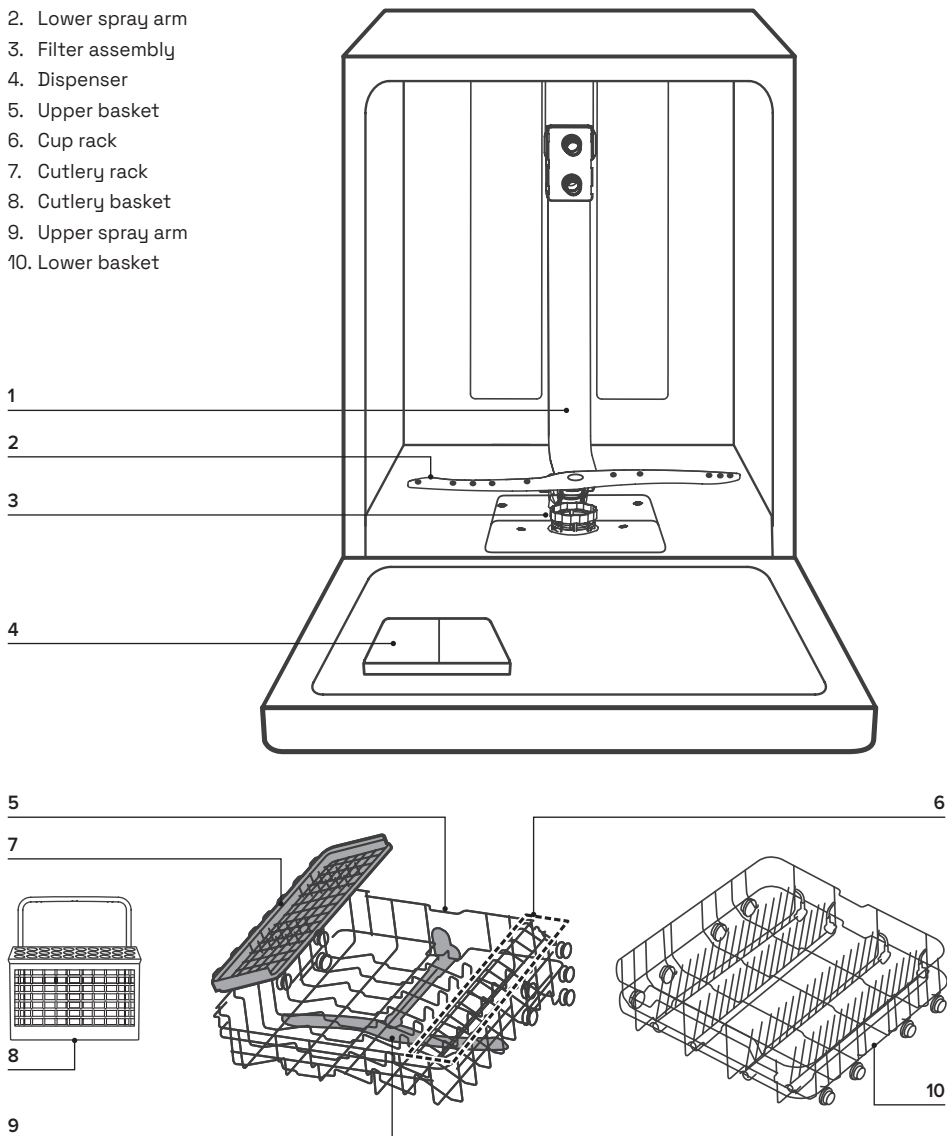

## Control Panel Overview



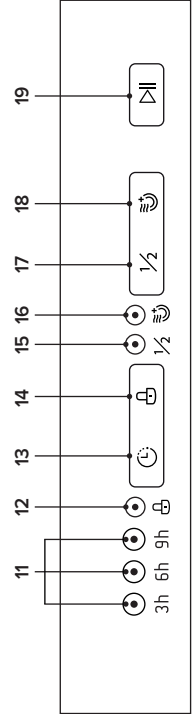
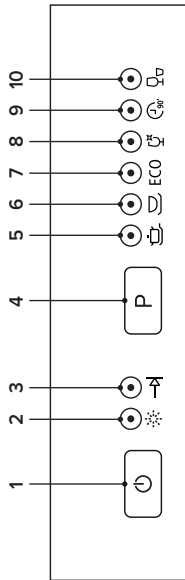



- |                          |                        |                              |                            |
|--------------------------|------------------------|------------------------------|----------------------------|
| 1. Power button          | 5. Intensive indicator | 10. Rapid indicator          | 15. Half load indicator    |
| 2. Rinse aid indicator   | 6. Heavy indicator     | 11. 3, 6, 9 hours indicators | 16. Extra drying indicator |
| 3. Program end indicator | 7. Eco indicator       | 12. Child lock indicator     | 17. Half load button       |
| 4. Program button        | 8. Glass indicator     | 13. Delay button             | 18. Extra drying button    |
|                          | 9. 90min indicator     | 14. Child lock button        | 19. Start/Pause button     |









# OPERATION

## How To Use the Control Panel

---

Controls	Description
 Power	Press this button to turn on your dishwasher.
 Program	Select the appropriate washing program, the selected program indicator will be lit.
 Delay Start	Press the Delay button to increase the delay start time. Delay a cycle for either 3, 6 or 9 hours
 Child Lock	This option allows you to lock the buttons on the control panel - except the Power button - so children cannot accidentally start the dishwasher by pressing the buttons on the panel. To lock or unlock the buttons on the control panel, press and hold the lock button for 3 seconds.
 Half Load	When you have about or less than 6 place setting dishware to wash, you can choose this function to save energy and water. It can be used with Intensive, ECO, Glass and 90min.
 Extra Drying	Add to cycle for an improved drying result. It can be used with Intensive, Heavy, ECO, Glass 90min.
 Start / Pause	To start the selected washing program or pause it when the dishwasher is working.

## Understanding the Programs and Indicators

Program / Indicator	Description
 Intensive	For heaviest soiled crockery, such as pots, pans and casserole dishes with dried on food.
 Heavy	For heavily soiled loads, such as plates, glasses and lightly soiled pots and pans.
ECO Eco	This is standard program, suitable for normally soiled loads, such as pots, plates, glasses and lightly soiled pans.
 Glass	For lightly soiled crockery and glass.
 90 min	For normally soiled loads that need quick wash.
 Rapid	A shorter wash for lightly soiled loads that do not need drying.
 Rinse Aid	If the indicator is lit, it means the dishwashers rinse aid is low.
 Program End	When the program is finished, the indicator will be lit.

## Function of Rinse Aid and Detergent

### Rinse Aid

The rinse aid is released during the final rinse to prevent water from forming droplets on your dishes, which can leave spots and streaks. It also improves drying by allowing water to roll off the dishes. Your dishwasher is designed to use liquid rinse aids.

- ⚠ Only use branded rinse aid for dishwasher. Never fill the rinse aid dispenser with any other substances (e.g. Dishwasher cleaning agent, liquid detergent). This would damage the appliance.

### Detergent

The chemical ingredients that compose the detergent are necessary to remove, crush and disperse all dirt out of the dishwasher. Most of the commercial quality detergents are suitable for this purpose.

- ⚠ Only use detergent specifically made for dishwashers use. Keep your detergent fresh and dry.
- ⚠ Don't put powdered detergent into the dispenser until you are ready to wash dishes.
- ⚠ Dishwasher detergent is corrosive! Keep dishwasher detergent out of the reach of children.

# OPERATION

## Filling the Rinse Aid Reservoir

The regularity of the dispenser needing to be refilled depends on how often dishes are washed and the rinse aid setting used. The Rinse Aid (☼) indicator will be lit when more rinse aid is needed.

1. Remove the rinse reservoir cap by lifting up the handle.
2. Pour the rinse aid into the dispenser, being careful not to overfill.
3. Close the cap after all.

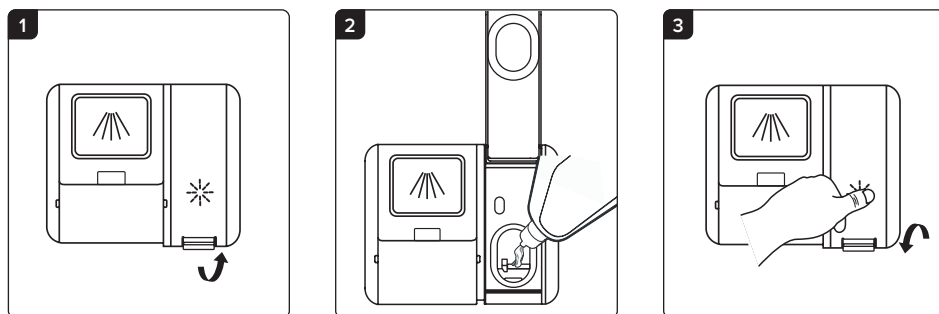

**i** Do not overfill the rinse aid dispenser.

## Adjusting the Rinse Aid Reservoir

To achieve a better drying performance with limited rinse aid, the dishwasher is designed to adjust the consumption by user. Follow the below steps.

1. Close the door, press the Power (⏻) button, to switch on the dishwasher.
2. Within 60 seconds after switching on, press the Program (P) button for more than 5 seconds, and then press the Delay Start (⏸) button, the Rinse Aid (☼) indication blinks as 1Hz frequency.
3. Press the Program (P) button again to select the program according to your using habits, the setting will change in the following sequence: d1->d2->d3->d4->d5->d1. The higher the number, the more rinse aid the dishwasher uses.
4. Leave for 5 seconds or press the Power (⏻) button to complete the setup and exit the setting mode.



## Filling the Detergent Dispenser

1. Please choose an open way according to your model: a) Open the cap by sliding the release latch;

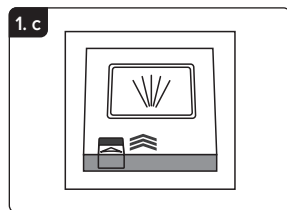
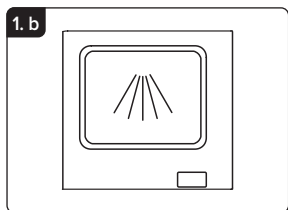
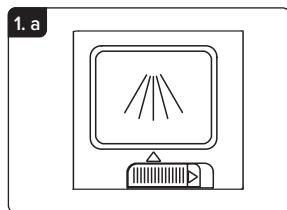

b) Open the cap by pressing down the release latch; c) Open the cap by pressing in the release latch.

2. Add detergent into the larger cavity (A) for main wash.

For better cleaning result, especially if you have very dirty items, pour a small amount of detergent onto the door. The additional detergent will activate during the pre-wash phase.

3. Close the flap by sliding it to the front and then pressing it down.

**i** Please follow the manufacturer's recommendations on the detergent packaging.

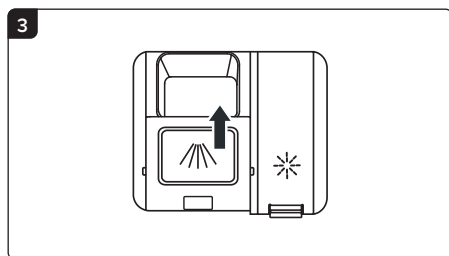
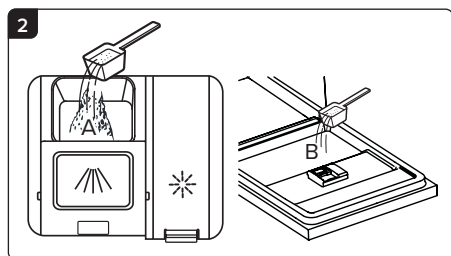

# OPERATION

## Basket Use and Tips

### Adjusting the upper basket

The height of the upper basket can be easily adjusted to accommodate taller dishes in either the upper or lower basket. To adjust the height of the upper rack, follow these steps:

1. Pull out the upper basket (lower position).
2. Remove the upper basket.
3. Re-attach the upper basket to upper or lower rollers.
4. Push in the upper basket (upper position).

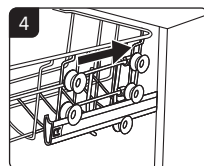
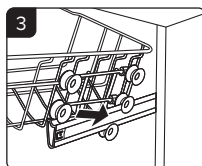
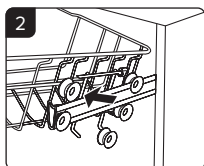
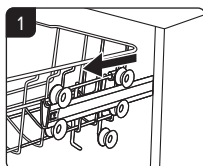

### Folding back the cup shelve

To make room for taller items in the upper basket, raise the cup rack upwards. You can then lean the tall glasses against it. You can also remove it when it is not required for use.

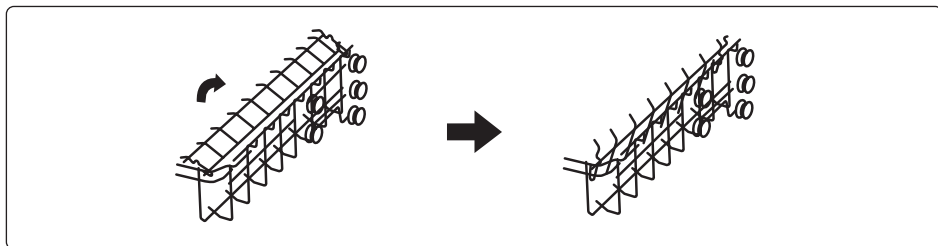

### Folding down the Rack Shelves

The racks of the lower basket are used for holding plates. They can be folded down to make more room for large items.

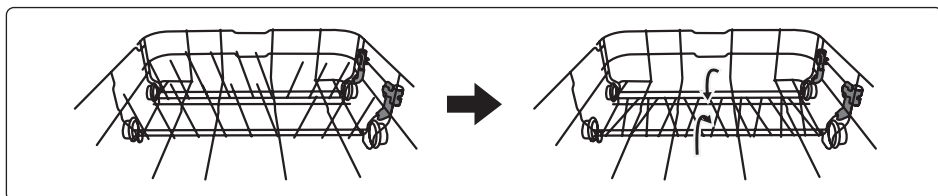

## Upper Basket: Top View

- 1. Cups
- 2. Saucers
- 3. Glasses
- 4. Dessert dishes
- 5. Forks
- 6. knives

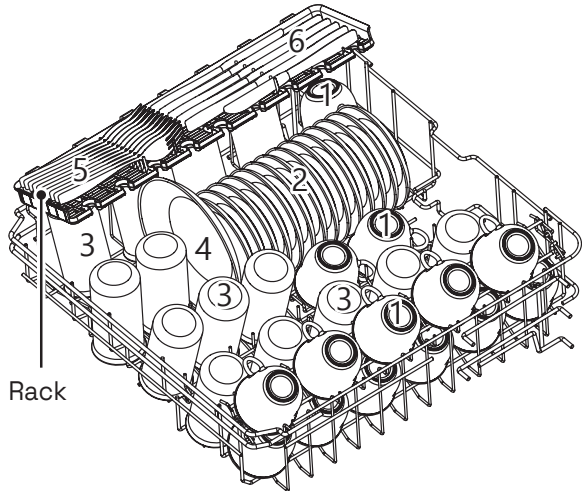

## Lower Basket: Top View

The lower rack is recommended for dinner plates, soup bowls, dishes, pots, pans, lids, and grill trays. Plates should be positioned vertically and facing the center of the rack. Make sure that large items do not interfere with the rotation of the spray arms, and do not prevent the detergent dispenser from opening.

There are two ways to load the cutlery baskets as follows:

- 7. Dinner plates
- 8. Soup plates
- 9. Cutlery basket
- 10. Oval plate

**1** Normal loading

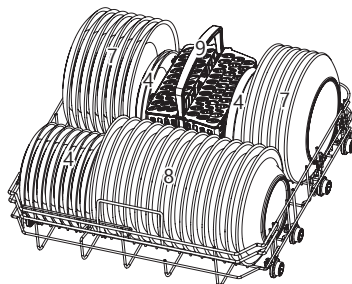

**2** Alternative loading

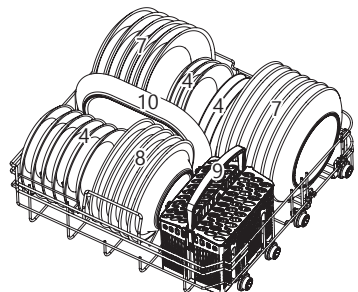

**i** Basket loading according to AS/NZS 2007.1.

# OPERATION

## Cutlery Rack and Basket: Top View

1. Forks
2. Knives
3. Teaspoons
4. Soup spoons
5. Dessert spoons

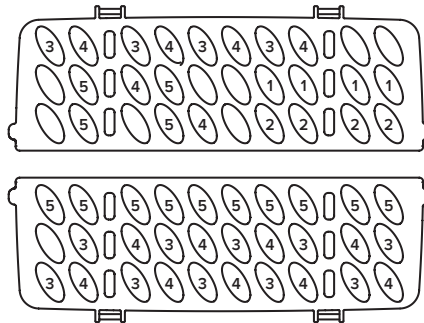
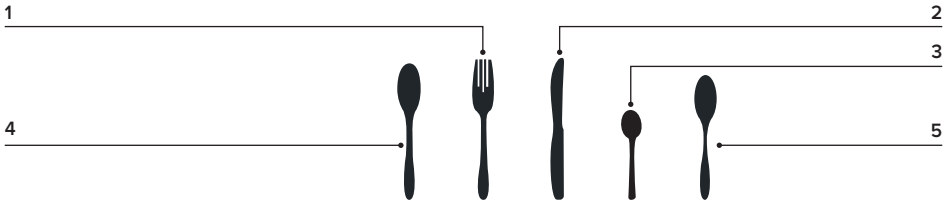
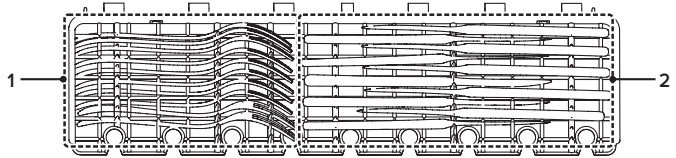

**i** Basket loading according to AS/NZS 2007.1.

- Information for comparability tests in accordance with (\*AS/NZS 2007.1)
- Capacity: 14 place settings
- Position of the upper basket: lower position
- Program: ECO
- Rinse aid setting: 6
- Detergent (Pre/main): 5g/27.5g
- Door is open at the end of the drying cycle for the drying performance test and last 40mins. (Door position: Open 50 mm)

## Preparing and Loading Dishes

---

- Consider buying utensils which are identified as dishwasher-proof.
- For particular items, select a program with the lowest possible temperature.
- To prevent damage, do not take glass and cutlery out of the dishwasher immediately after the program has ended.

For washing the following cutlery/dishes

ARE NOT Suitable	OF LIMITED Suitability
<ul style="list-style-type: none"> <li>• Cutlery with wooden, horn china or; mother-of-pearl handles</li> <li>• Plastic items that are not heat resistant</li> <li>• Older cutlery with glued parts that are not temperature resistant</li> <li>• Bonded cutlery items or dishes</li> <li>• Pewter or cooper items</li> <li>• Crystal glass</li> <li>• Steel items subject to rusting</li> <li>• Wooden platters</li> <li>• Items made from synthetic fibres</li> </ul>	<ul style="list-style-type: none"> <li>• Some types of glasses can become dull after a large number of washes</li> <li>• Silver and aluminum parts have a tendency to discolor during washing</li> <li>• Glazed patterns may fade if machine washed frequently</li> </ul>

# OPERATION

## Preparing and Loading Dishes *(Continued)*

---

### Recommendations for loading the dishwasher

Scrape off any large amounts of leftover food. Soften remnants of burnt food in pans. It is not necessary to rinse the dishes under running water.

- (i) For best performance of the dishwasher, follow these loading guidelines.
- (i) Features and appearance of baskets and cutlery baskets may vary from your model.

### Place objects in the dishwasher in following way:

- Items such as cups, glasses, pots, pans, etc. are faced downwards.
  - Curved items, or ones with recesses, should be loaded aslant so that water can run off.
  - All utensils are stacked securely and can not tip over.
  - All utensils are placed in the way that the spray arms can rotate freely during washing.
  - Load hollow items such as cups, glasses, pans etc. With the opening facing downwards so that water cannot collect in the container or a deep base.
  - Dishes and items of cutlery must not lie inside one another, or cover each other. To avoid damage, glasses should not touch one another.
  - The upper basket is designed to hold more delicate and lighter dishware such as glasses, coffee and tea cups.
  - Long bladed knives stored in an upright position are a potential hazard.
  - Long and sharp items of cutlery such as carving knives must be positioned horizontally in the upper basket.
  - Please do not overload your dishwasher. This is important for good results and for reasonable consumption of energy.
- (i) Very small items should not be washed in the dishwasher as they could easily fall out of the basket.

### Loading the upper basket

The upper basket is designed to hold more delicate and lighter dishware such as glasses, coffee and tea cups and saucers, as well as plates, small bowls and shallow pans (as long as they are not too dirty). Position the dishes and cookware so that they will not get moved by the spray of water.

### Loading the lower basket

We suggest that you place large items and the most difficult to clean items are to be placed into the lower basket: such as pots, pans, lids, serving dishes and bowls, as shown in the figure

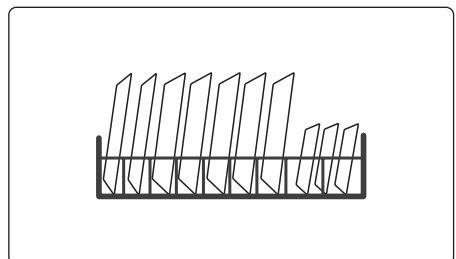
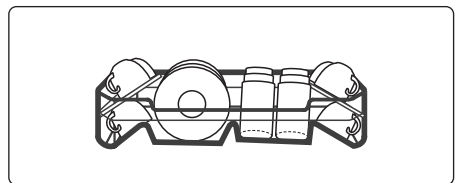

## Preparing and Loading Dishes (Continued)

below. It is preferable to place serving dishes and lids on the side of the racks in order to avoid blocking the rotation of the top spray arm. The maximum diameter advised for plates in front of the detergent dispenser is of 19 cm, this not to hamper the opening of it.



**⚠** Do not let any item extend through the bottom. Always load sharp utensils with the sharp point down.

### Loading the cutlery basket

Cutlery should be placed in the cutlery basket separately from each other in the appropriate positions, and do make sure the utensils do not nest together, this may cause bad performance.

### Removing the dishes

To prevent water dripping from the upper basket into the lower basket, we recommend that you empty the lower basket first, followed by the upper basket.

**⚠** Items will be hot! To prevent damage, do not take glass and cutlery out of the dishwasher for around 15 minutes after the program has ended.

## Programming the Dishwasher: Wash Cycle Table

The table below shows which programs are best for the levels of food residue on them and how much detergent is needed. It also show various information about the programs.

Program	Description	Detergent pre / main	Running time (min)	Energy (kWh)	Water (L)	Rinse aid
Intensive	Pre-wash: 50°C > Wash: 65°C > Rinse > Rinse: 75°C > Drying	5 / 27.5g or all in 1	160	1.800	18.5	●
Heavy	Pre-wash: 50°C > Wash: 65°C > Rinse > Rinse: 75°C > Drying	5 / 27.5g or all in 1	150	1.401	14.9	●
ECO *AS / NZS 2007.1	Pre-wash > Wash: 45°C > Rinse > Rinse: 52°C > Drying	5 / 27.5g or all in 1	180	0.86	12.03	●
Glass	Pre-wash > Wash: 42°C > Rinse > Rinse: 60°C > Drying	5 / 27.5g or all in 1	125	0.901	14.6	●
90min	Wash: 65°C > Rinse > Rinse: 66°C > Drying	32.5g or all in 1	90	1.204	11.6	●
Rapid	Wash: 40°C > Rinse > Rinse: 45°C	27.5g	30	0.604	11.7	○

**i** \*AS / NZS 2007.1: This program is the test cycle.  
The information for comparability test in accordance with AS/NZS 2007.1.

# OPERATION

## Starting a Wash Cycle

---

1. Draw out the lower and upper basket, load the dishes and push them back.  
It is recommended to load the lower basket first, then the upper one.
2. Pour in the detergent.
3. Insert the plug into the socket. For the power supply refer to last page 'Technical Specifications'.  
Make sure that the water supply is turned on to full pressure.
4. Close the door, press the Power (⏻) button, to switch on the dishwasher.
5. Choose a program, the response light will turn on (●).  
Press the Start/Pause (▶||) button, the dishwasher will start its cycle.

## Changing the Program Mid-Cycle

---

A wash cycle can only be changed if it has been running for a short time otherwise, the detergent may have already been released and the dishwasher may have already drained the wash water. If this is the case, the dishwasher needs to be reset and the detergent dispenser must be refilled. To reset the dishwasher, follow the instructions below:

1. Press the Start/Pause (▶||) button to pause the washing.
2. Press Program (P) button for more than 3 seconds, the program will cancel.
3. Press the Program (P) button to select the desired program.
4. Press the Start/Pause (▶||) button, after 10 seconds, the dishwasher will start.

## Add a Dish During a Cycle

---

A forgotten dish can be added any time before the detergent dispenser opens. If this is the case, follow the instructions below:

1. Press the Start/Pause (▶||) button to pause the washing.
2. Wait 5 seconds then open the door.
3. Add the dishes.
4. Close the door.
5. Press the Start/Pause (▶||) button after 10 seconds, the dishwasher will start.

**⚠** It is dangerous to open the door mid-cycle, as hot steam may scald you.



## External Care

---

### The door and the door seal

Clean the door seals regularly with a soft damp cloth to remove food deposits. When the dishwasher is being loaded, food and drink residues may drip onto the sides of the dishwasher door. These surfaces are outside the wash cabinet and are not accessed by water from the spray arms. Any deposits should be wiped off before the door is closed.

### The control panel

If cleaning is required, the control panel should be wiped with a soft damp cloth only.

- ⚠ To avoid penetration of water into the door lock and electrical components, do not use a spray cleaner of any kind.
- ⚠ Never use abrasive cleaners or scouring pads on the outer surfaces because they may scratch the finish. Some paper towels may also scratch or leave marks on the surface.

## Internal Care

---

### Filtering system

The filtering system in the base of the wash cabinet retains coarse debris from the washing cycle. The collected coarse debris may cause the filters to clog. Check the condition of the filters regularly and clean them if necessary under running water. Follow the steps below to clean the filters in the wash cabinet.

ⓘ Pictures are only for reference, different models of the filtering system and spray arms may be different.

1. Hold the coarse filter and rotate it anticlockwise to unlock the filter. Lift the filter upwards and out of the dishwasher.
2. The fine filter can be pulled off the bottom of the filter assembly. The coarse filter can be detached from the main filter by gently squeezing the tabs at the top and pulling it away.

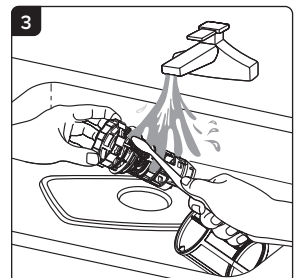
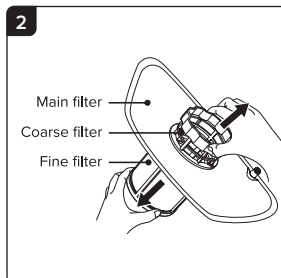
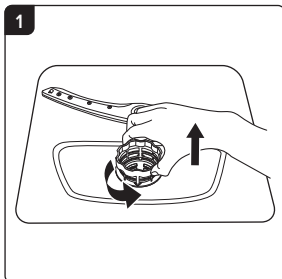

# MAINTENANCE & CLEANING

## Internal Care *(Continued)*

3. Larger food remnants can be cleaned by rinsing the filter under running water. For a more thorough clean, use a soft cleaning brush.
4. Reassemble the filters in the reverse order of the disassembly, replace the filter insert, and rotate clockwise to the close arrow.

**⚠** Do not over tighten the filters. Put the filters back in sequence securely, otherwise coarse debris could get into the system and cause a blockage.

**⚠** Never use the dishwasher without filters in place. Improper replacement of the filter may reduce the performance level of the appliance and damage dishes and utensils.

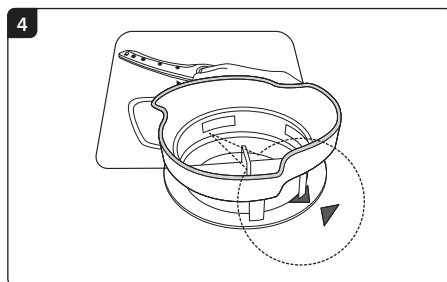

## Spray arms

It is necessary to clean the spray arms regularly as hard water chemicals will clog the spray arm jets and bearings. To clean the spray arms, follow the instructions below:

1. To remove the upper spray arm, hold the nut, rotate the arm clockwise to remove it.
2. To remove the lower spray arm, pull out the spray arm upward.
3. Wash the arms in soapy and warm water and use a soft brush to clean the jets. Replace them after rinsing them thoroughly.

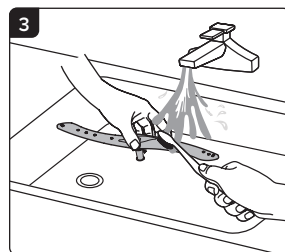
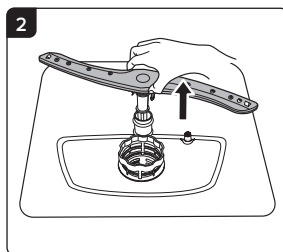
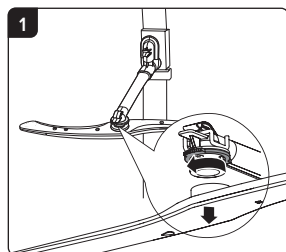

## Caring for the Dishwasher

---

### **Frost precaution**

Please take frost protection measures on the dishwasher in winter. Every time after running wash cycles, please operate as follows:

1. Cut off the electrical power to the dishwasher at the supply source.
2. Turn off the water supply and disconnect the water inlet pipe from the water valve.
3. Drain the water from the inlet pipe and water valve. (Use a pan to gather the water)
4. Reconnect the water inlet pipe to the water valve.
5. Remove the filter at the bottom of the tub and use a sponge to soak up water in the sump.

### **After every wash**

After every wash, turn off the water supply to the appliance and leave the door slightly open so that moisture and odors are not trapped inside.

### **Remove the plug**

Before cleaning or performing maintenance, always remove the plug from the socket.

### **No solvents or abrasive cleaning**

To clean the exterior and rubber parts of the dishwasher, do not use solvents or abrasive cleaning products. Only use a cloth with warm soapy water. To remove spots or stains from the surface of the interior, use a cloth dampened with water and a little vinegar, or a cleaning product made specifically for dishwashers.

### **When not in use for a longtime**

It is recommended that you run a wash cycle with the dishwasher empty and then remove the plug from the socket, turn off the water supply and leave the door of the appliance slightly open. This will help the door seals to last longer and prevent odors from forming within the appliance.

### **Moving the appliance**

If the appliance must be moved, try to keep it in the vertical position. If absolutely necessary, it can be positioned on its back.

### **Seals**

One of the factors that cause odours to form in the dishwasher is food that remains trapped in the seals. Periodic cleaning with a damp sponge will prevent this from occurring.

# TROUBLE SHOOTING

## Before Calling For Service

Reviewing the charts on the following pages may save you from calling for service.

Problem	Possible Cause	Try
Dishwasher doesn't start	<ul style="list-style-type: none"> <li>a) Fuse blown, or the circuit break tripped.</li> <li>b) Power supply is not turned on.</li> <li>c) Water pressure is low.</li> <li>d) Door of dishwasher not properly closed.</li> </ul>	<ul style="list-style-type: none"> <li>a) Replace fuse or reset circuit breaker. Remove any other appliances sharing the same circuit with the dishwasher.</li> <li>b) Make sure the dishwasher is turned on and the door is closed securely. Make sure the power cord is properly plugged into the wall socket.</li> <li>c) Check that the water supply is connected properly and the water is turned on.</li> <li>d) Make sure to close the door properly and latch it.</li> </ul>
Water not pumped form dishwasher	<ul style="list-style-type: none"> <li>a) Twisted or trapped drain hose.</li> <li>b) Filter clogged.</li> <li>c) Kitchen sink clogged.</li> </ul>	<ul style="list-style-type: none"> <li>a) Check the drain hose.</li> <li>b) Check coarse the filter.</li> <li>c) Check the kitchen sink to make sure it is draining well. If the problem is the kitchen sink that is not draining, you may need a plumber rather than a serviceman for dishwashers.</li> </ul>
Suds in the tub	<ul style="list-style-type: none"> <li>a) Wrong detergent.</li> <li>b) Spilled rinse-aid.</li> </ul>	<ul style="list-style-type: none"> <li>a) Use only the special dishwasher detergent to avoid suds. If this occurs, open the dishwasher and let suds evaporate. Add 1 gallon of cold water to the bottom of the dishwasher. Close the dishwasher door, then select any cycle. Initially, the dishwasher will drain out the water. Open the door after draining stage is complete and check if the suds have disappeared. Repeat if necessary.</li> <li>b) Always wipe up rinse-aid spills immediately.</li> </ul>

## TROUBLE SHOOTING

### Before Calling For Service *(Continued)*

Problem	Possible Cause	Try
Stained tub interior	a) Detergent with colourant may have been used.	a) Make sure that the detergent has no colourant.
White film on inside surface	a) Hard water minerals.	a) To clean the interior, use a damp sponge with dishwasher detergent and wear rubber gloves. Never use any other cleaner than dishwasher detergent otherwise, it may cause foaming or suds.
There are rust stains on cutlery	a) The affected items are not corrosion resistant.	a) The items should be corrosion resistant.
Knocking noise in the dishwasher	a) A spray arm is knocking against an item in a basket	a) Interrupt the program and rearrange the items which are obstructing the spray arm.
Rattling noise in the dishwasher	a) Items of crockery are loose in the dishwasher.	a) Interrupt the program and rearrange the items of crockery.
Knocking noise in the water pipes	a) This may be caused by on-site installation or the cross-section of the piping.	a) This has no influence on the dishwasher function. If in doubt, contact a qualified plumber.
The dishes are not clean	<ul style="list-style-type: none"> <li>a) The dishes were not loaded correctly.</li> <li>b) The program was not powerful enough.</li> <li>c) Not enough detergent was dispensed.</li> <li>d) Items are blocking the movement of the spray arms.</li> <li>e) The filter combination is not clean or is not correctly fitted in the base of wash cabinet. This may cause the spray arm jets to get blocked.</li> </ul>	<ul style="list-style-type: none"> <li>a) See notes in "Loading &amp; unloading your dishwasher".</li> <li>b) Select a more intensive program.</li> <li>c) Use more detergent, or change your detergent.</li> <li>d) Rearrange the items so that the spray can rotate freely.</li> <li>e) Clean and/or fit the filter correctly. Clean the spray arm jets.</li> </ul>
Cloudiness on glassware	a) Combination of soft water and too much detergent.	a) Use less detergent if you have soft water and select a shorter cycle to wash the glassware and to get them clean.

# TROUBLE SHOOTING

## Before Calling For Service *(Continued)*

Black or grey marks on dishes	a) Aluminium utensils have rubbed against dishes	a) Use a mild abrasive cleaner to eliminate those marks.
Problem	Possible Cause	Try
Detergent left in dispenser	a) Dishes block detergent dispenser.	a) Re-loading the dishes properly.
The dishes aren't drying	<p>a) Improper loading.</p> <p>b) Too little rinse-aid.</p> <p>c) Dishes are removed too soon.</p> <p>d) Wrong program has been selected.</p> <p>e) Use of cutlery with a low-quality coating.</p>	<p>a) Load the dishwasher as suggested in the directions.</p> <p>b) Increase the amount of rinse-aid/ refill the rinse-aid dispenser.</p> <p>c) Do not empty your dishwasher immediately after washing. Open the door slightly so that the steam can come out. Take out the dishes until the inside temperature is safe to touch. Unload the lower basket first to prevent the dropping water from the upper basket.</p> <p>d) With a short program, the washing temperature is lower, decreasing cleaning performance. Choose a program with a long washing time.</p> <p>e) Water drainage is more difficult with these items. Cutlery or dishes of this type are not suitable for washing in the dishwasher.</p>

## Error Codes

---

If there is a malfunction, the dishwasher will display error codes to identify these:

Code	Meaning	Possible Cause
The Rapid light flickers quickly	Longer inlet time.	Faucets is not opened, or water intake is restricted, or water pressure is too low.
The Rapid and 90Min light flickers quickly	Not reaching required temperature.	Malfunction of heating element.
The Glass light flickers quickly	Overflow.	Some element of dishwasher leaks.
The ECO, Glass light flickers quickly	Failure of communication between main circuit board with display circuit board.	Open circuit or break wiring for the communication.

- ⚠ If overflow occurs, turn off the main water supply before calling a service.
- ⚠ If there is water in the base pan because of an overflow or small leak, the water should be removed before restarting the dishwasher.

# TECHNICAL SPECIFICATIONS

## Product Dimensions

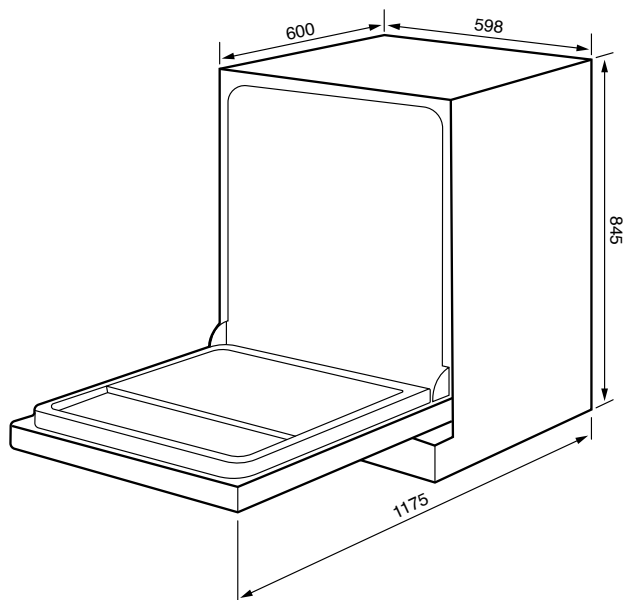

Dimensions	
Width	598mm
Height	845mm
Depth	600mm (with door closed) / 1175mm (with door open 90°)

- ① Specification according to EU Directive 1016/2010 & 1059/2010
- ① Technical specifications of this product are subject to specification without notice to improve the quality of the product.
- ① Figures in this manual are schematic and may not match the product exactly.
- ① Values stated on markers on this product or in the other published documentation accompanying with this product are obtained in laboratory in accordance with the relevant standards.  
Depending on operational and environmental conditions of this product, these values may vary.



# TECHNICAL SPECIFICATIONS

## Product Fiche

---

Model	GDW14S-2
Manufacturer	Glen Dimplex
Standard Place Settings	14
Energy Efficiency Class	3 Stars
Water Consumption Class	4.5 Star
Standard Cleaning Cycle	ECO
Energy Consumption of the Standard Cleaning Cycle	0.85kWh
Water Consumption of the Standard Cleaning Cycle	12.2L
Program Duration of the Standard Cleaning Cycle	180mins
Noise Level	49dB(A) re 1pW
Mounting	Freestanding
Built-in Option	Yes
Power Consumption	1760 - 2100W
Rated Voltage / Frequency	AC 220 - 240V / 50Hz
Water Pressure (Flow Pressure)	0.04 - 1.0MPa = 0.4 - 10bar

① Specification according to EU Directive 1016/2010 & 1059/2010

# MANUFACTURER GUARANTEE

This warranty is provided in Australia by Glen Dimplex Australia Pty Limited ABN 69 118 275 460 (Phone number 1300 556 816) and in New Zealand by Glen Dimplex New Zealand Limited NZBN 9429000069823 (Phone number 09 274 8265) in respect of the Glen Dimplex product.

## 1. Glen Dimplex Express Warranty

Subject to the exclusions below, we warrant that the product will not have any electrical or mechanical breakdowns within:

- a) In the case of Glen Dimplex products used for personal, domestic or household purposes, a period of 2 years from the date the product is purchased as a brand-new product from a retailer located in Australia / New Zealand.
- b) In the case of Glen Dimplex products used for purposes other than personal, domestic or household purposes (including business or commercial use), a period of 90 days from the date the product is purchased as a brand-new product from a retailer located in Australia / New Zealand. Glen Dimplex products are designed and intended for domestic use only; and
- c) All warranty repairs must be carried out by Glen Dimplex or their nominated service agent.

Note: warranty periods detailed above may vary in line with agreements with select retail and builder partners and may differ between Australia and New Zealand.

The benefits conferred by this express warranty are in addition to the Consumer Guarantees referred to in section 3 and any other statutory rights you may have under the Australian / New Zealand Consumer Law and / or other applicable laws.

## 2. Warranty Exclusions

This express warranty does not apply where:

- a) The product has been installed, used or operated otherwise than in accordance with the product manual or other similar documentation provided to you with the product;
- b) The product requires repairs due to damage resulting from accident, misuse, incorrect installation, insect or vermin infestation, improper liquid spillage, cleaning or maintenance, unauthorised modification, use on an incorrect voltage, power surges and dips, voltage supply problems, tampering or unauthorised repairs by any persons, use of defective or incompatible accessories or exposure to abnormally corrosive conditions, events independent of human control which occurred after the goods left the control of Glen Dimplex;
- c) The repair relates to the replacement of consumable parts such as fuses and bulbs or any other parts of the product which require routine replacement;
- d) You are unable to provide us with reasonable proof of purchase for the product;
- e) The breakdown occurs after the expiry of the express warranty period set out in section 1 or;
- f) The product was not purchased in Australia / New Zealand as a brand-new product.

### 3. Consumer Guarantees

Our goods come with guarantees that cannot be excluded under the Australian / New Zealand Consumer Law. You are entitled to a replacement or refund for a major failure and for compensation for any other reasonably foreseeable loss or damage. You are also entitled to have the goods repaired or replaced if the goods fail to be of acceptable quality and the failure does not amount to a major failure.

### 4. How to Make a Claim

You may make a claim under this warranty through our website, contacting our customer care line or via email. Contact details for Glen Dimplex Australia and New Zealand can be found at the end of this document.

To make a valid claim under this warranty, you must:

- a) Lodge the claim with us as soon as possible and no later than 14 days after you first become aware of the breakdown;
- b) Provide us with the product serial number;
- c) Provide us with reasonable proof of purchase for the product. This can take the form of a store receipt, new home handover form or other payment receipt documentation; and
- d) If required by us, provide us (or any person nominated by us) with access to the premises at which the product is located at times nominated by us (so that we can inspect the product).

### 5. Warranty Claims

If you make a valid claim under this warranty and none of the exclusions set out in section 2 apply, we will, at our election, either repair the product or replace the product with a product of identical specification (or where the product is superseded or no longer in stock, with a product of as close a specification as possible).

Goods presented for repair may be replaced by refurbished goods of the same type rather than being repaired. Refurbished parts may be used to repair the goods. Products are designed and supplied for normal domestic use. We will not be liable to you under this warranty for business loss or damage of any kind whatsoever.

#### Contact our Customer Care Team

---

Glen Dimplex Australia Pty Ltd  
Ph: 1300 556 816  
customer.care.ha@glendimplex.com.au  
www.glendimplex.com.au

Glen Dimplex New Zealand Ltd  
Ph: 09 274 8265  
nztechserv@glendimplex.co.nz  
www.glendimplex.co.nz







## **READ THE INSTRUCTION BOOKLET BEFORE INSTALLING AND USING THE APPLIANCE.**

The manufacturer will not be responsible for any damage to property or to persons caused by incorrect installation or improper use of the appliance. The manufacturer is not responsible for any inaccuracies, due to printing or transcription errors, contained in this manual. In addition, the appearance of the figures reported is also purely indicative.

The manufacturer reserves the right to make changes to its products when considered necessary and useful, without affecting the essential safety and operating characteristics. Glen Dimplex constantly seeks ways to improve the specifications and designs of their products. Whilst every effort is made to produce up to date literature, this document should not be regarded as an infallible guide. Actual product only should be used to derive cut out sizes.

All appliances must be installed by a qualified person(s) with adherence to the relevant electrical, plumbing and building codes, with compliance being issued as required by state or national legislation.

Additionally, all upright cookers must have the anti-tilt device installed correctly in adherence to the relevant standards by a licenced installer.

For maximum effectiveness and efficiency all rangehoods should be installed with the use of ductwork, by a licenced installer with adherence to the relevant state and national building codes and regulations.

All Glen Dimplex appliances are for Domestic use only, and must be installed by a licenced installer into Domestic Applications only, without exception and to the required Authorities guidelines. Any installation outside of this will VOID warranty. Alfresco areas are not a Domestic application.



### Distributed by

---

Glen Dimplex Australia Pty Ltd  
Ph: 1300 556 816  
customer.care.ha@glendimplex.com.au

Glen Dimplex New Zealand Ltd  
Ph: 09 274 8265  
nztechserv@glendimplex.co.nz

For service advice, please contact the Customer Care Centre by phone or email above.

For full terms and conditions, or to register your product warranty, please visit our website:

[www.glendimplex.com.au](http://www.glendimplex.com.au)

[www.glendimplex.co.nz](http://www.glendimplex.co.nz)

