

Instructions for Use and Installation
Multifunction 90cm Oven

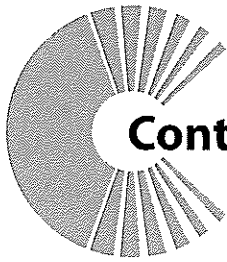

Data Label

SPARE DATA LABEL



Contents

For Your Safety	3
------------------------------	----------

Use and Care

Controls	6
Oven & accessories	8
How to use your oven	9
Positioning the oven trays & shelves	11
Cooking modes	12
Using the Controls - Control Knob models	13
Using the Controls - Sensor Touch models	18
Rotisserie	25
Practical cooking advice	26
Cooking guide	31
Cleaning and maintenance	33
How to remove the oven door	34
Replacing the oven lamp	35
Disposal	35

Installation

Cabinet details	36
Electrical connection	37
Technical data	38

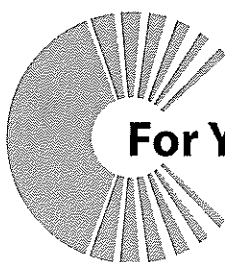

For Your Safety

We recommend that you read the instructions in this owner's manual carefully before use for the best performance and to extend the life of your appliance. It will provide you with all the information you need to ensure its safe installation, use and maintenance. Retain this owner's manual for future reference.

When handling the appliance, we recommend you always use the handles recessed into the sides of the oven to prevent personal injury or damage to the appliance.

To maintain the efficiency and safety of this appliance, we recommend that you do the following:

- Always call the Technika service department if there are any faults with your appliance.
- Always use original spare parts available from Technika.
- This appliance is designed for non-commercial, household use and it must not be altered in any way.
- **This appliance can only be used safely when it is correctly connected to an efficient earthing system in compliance with current electrical safety standards.**
- **If the supply cord is damaged, it must be replaced by the manufacturer or its service agent or a similarly qualified person in order to avoid a hazard.**
- **During use, the appliance becomes hot. Care should be taken to avoid touching heating elements inside the oven. WARNING: Accessible parts will become hot when in use. To avoid burns and scalds, children should be kept away.**
- **This appliance is not intended for use by persons (including children) with reduced physical, sensory or mental capabilities, or lack of experience and knowledge, unless they have been given supervision or instruction concerning use of the appliance by a person responsible for their safety.**
- **Young children should be supervised to ensure that they do not play with the appliance.**
- **DO NOT use a steam cleaner to clean the appliance.**

Packaging items such as plastic bags, polystyrene, nails, etc. are potentially dangerous, and therefore appropriate measures must be taken to prevent children and the disabled from coming into contact with them.

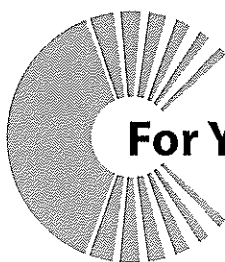

For Your Safety

Avoid the following:

- Touching the appliance with wet parts of the body.
- Using the appliance while barefoot.
- Pulling on the supply cable to unplug it from the electrical outlet.
- Improper or dangerous operation.
- Obstructing the ventilation or heat dissipation slots.
- Allowing power supply cables of other appliances to come into contact with hot parts of the oven.
- Exposing the appliance to atmospheric agents such as rain, or direct sunlight.
- Using the oven for storage purposes.
- Using flammable liquids near the appliance.
- Using adapters, multiple sockets and / or extension leads.
- Attempting to install or repair the appliance without the assistance of authorised personnel.

Authorised personnel must be contracted to...

- Install the appliance according to these installation instructions and any local requirements.
- Replace the temperature probe if it is damaged. The probe is part of thermostat. Only use the temperature sensing probe recommended for this oven.

Technika Service Department must be contacted...

- If in doubt about the operation of the appliance.
- If in doubt about the soundness of the appliance after removing it from its packaging.
- If the power supply cable has been damaged or needs to be replaced.
- If the appliance requires a service.
- If you need spare parts.

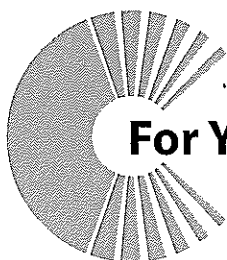

For Your Safety

WARNINGS:

- **DO NOT** steam clean the oven.
- **DO NOT** use harsh abrasive cleaners or sharp metal scrapers to clean the oven door glass since they can scratch the surface, which may result in shattering of the glass.
- **Only** use the appliance to cook food and nothing else.
- Check that the appliance has not been damaged immediately after it has been unpacked.
- **Disconnect** the appliance from the electrical mains if it is not functioning properly and before cleaning or performing maintenance.
- **When left unused** for a long period, unplug the appliance from the electricity mains.
- **Use oven gloves** to place cookware in the oven or when removing it.
- **Always grip** the oven door handle in the centre.
- **Make sure** the control knobs (where fitted) are in the '0' or '●' position when the appliance is not in use.
- **Technika will not accept any liability** as a result of any damage due to incorrect installation or improper use.

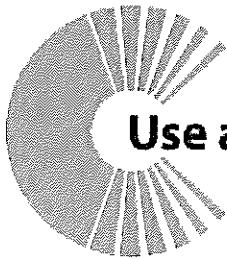

Use and Care

Sensor Touch Control model

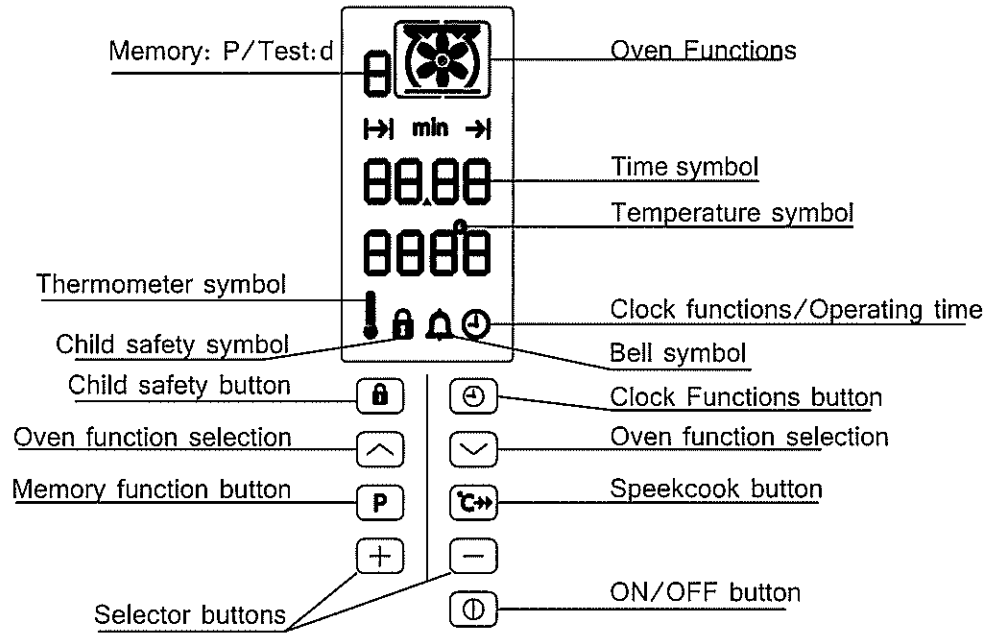

Oven & accessories

Ovens are supplied with a bottom hinged door, chrome wire shelf supports, four shelf positions and a range of shelf options as shown below.

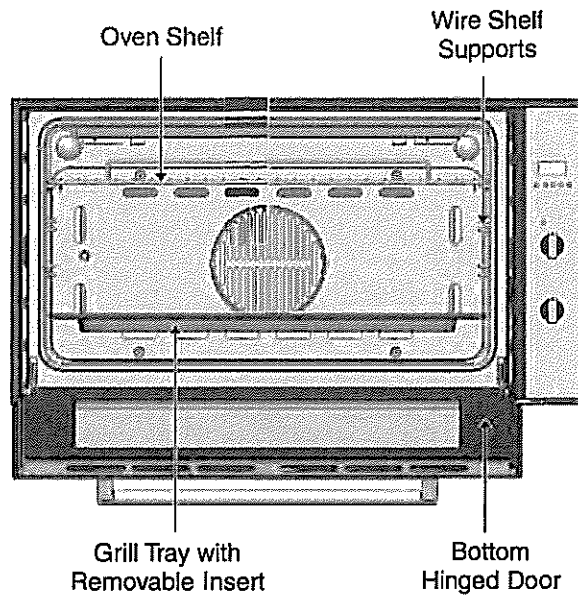

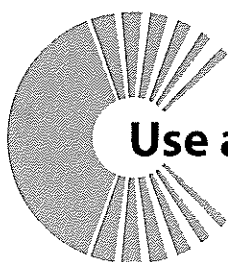

Use and Care

How to use your oven - Manual Control Knob models

This multi-function oven combines the advantages of traditional convection ovens with modern fan assisted ovens in a single appliance. It is an extremely versatile appliance that allows you to choose easily and safely between different cooking modes. The various cooking modes are selected by means of a cooking mode selection knob, located on the control panel.

To operate the oven:

- Ensure that manual mode is selected (page 15)
- Turn the cooking mode selection knob to the desired cooking mode (explanation of cooking modes is on pages 12 to 14)
- Turn the cooking temperature selection knob to the desired temperature (cooking guide is on pages 31 to 32) or to 'MAX' if Grilling.

The first time you use your appliance, we recommend that you set the thermostat to the highest setting, set the cooking mode selection knob to a cooking mode and leave the oven on for about half an hour with nothing in it and the oven door closed. Then, open the oven door and allow the oven to cool. Any odour that may be detected during this initial use is due to the evaporation of substances used to protect the oven during storage.

Note: Place tray on the bottom shelf position of the oven to prevent any spillages from dripping onto the bottom of the oven. **Never place anything (including foil and oven trays) on the bottom of the oven when it is in operation because this could damage the enamel.** Only place your cookware (dishes, trays, aluminum foil, etc.) on the oven shelves provided with the appliance.

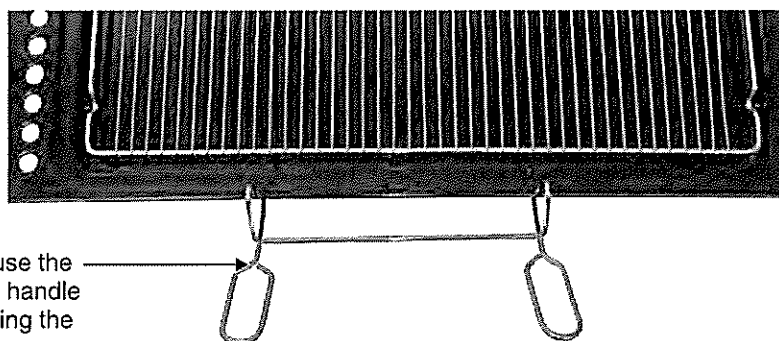

If supplied, use the chrome wire handle when removing the tray from the oven.

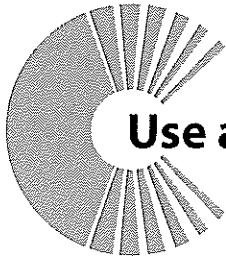





Use and Care

How to use your oven - Sensor Touch Control Panel models

This multi-function oven combines the advantages of traditional convection ovens with modern fan assisted ovens in a single appliance. It is an extremely versatile appliance that allows you to choose easily and safely between different cooking modes. The various cooking modes are selected using the sensor touch control panel.

To operate the oven:

- Switch on the oven using the  button.
- Select the desired cooking mode using the  and  buttons (explanation of cooking modes is on pages 12 to 14)
- A suggested cooking temperature will appear on the display. Use the  and  buttons to change to a desired temperature (cooking guide is on pages 31 to 32) or to '**MAX**' if Grilling.

The first time you use your appliance, we recommend that you set the thermostat to the highest setting, set the oven to any cooking mode using the touch control panel and leave the oven on for about half an hour with nothing in it and the oven door closed. Then, open the oven door and allow the oven to cool. Any odour that may be detected during this initial use is due to the evaporation of substances used to protect the oven during storage.

Note: Place tray on the bottom shelf position of the oven to prevent any spillages from dripping onto the bottom of the oven. **Never place anything (including foil and oven trays) on the bottom of the oven when it is in operation because this could damage the enamel.** Only place your cookware (dishes, trays, aluminum foil, etc.) on the oven shelves provided with the appliance.

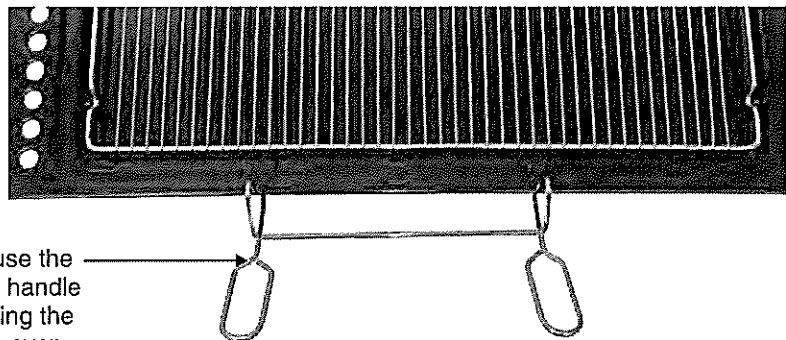

If supplied, use the chrome wire handle when removing the tray from the oven.

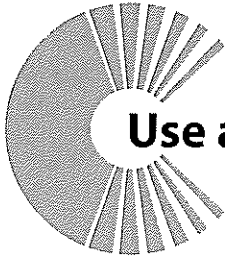

Use and Care

Positioning the oven trays & shelves

The Grill Tray or Oven Shelf can be located in any of the four height positions in the oven.

Refer to the 'Cooking Guide Table' for the recommended shelf position. When fitting the trays or shelves, ensure they are fitted between the two wires that are closest together as shown below. Oven Shelves have a stop so that they are not fully withdrawn by accident. To fully remove the Oven Shelves, lift the front of the shelf slightly and withdraw fully from the oven. Note that the Grill Tray does not have a stop position and can be fully withdrawn without interruption, so be careful not to accidentally fully withdraw the tray.

Fit Trays and Shelves between bars as shown right

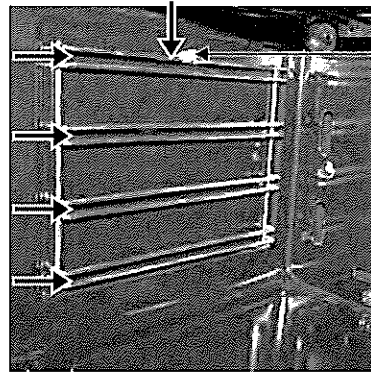

Locking pin

To remove the Oven Shelf Support, push down on the wire below the locking pin, pull away from the oven wall until you can release the top of the support from the holes in the oven wall. Replace in reverse procedure.

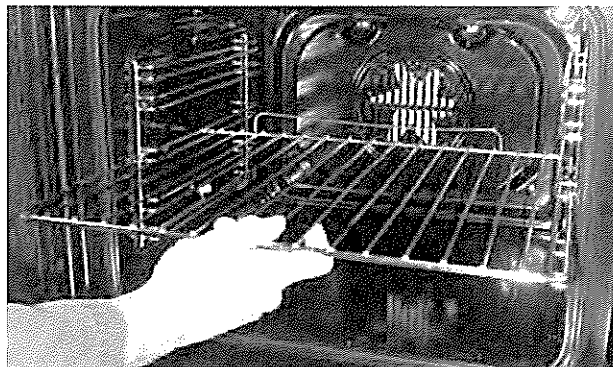

Oven Shelf fitted to chrome wire Shelf Support

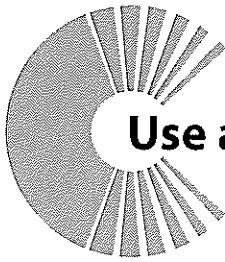

Use and Care

COOKING MODES

Convection mode

Position the cooking temperature selection knob between 60°C and 'Max' for this setting. When set to Convection mode, the top and bottom heating elements operate together like a 'normal' conventional oven that you have probably used before.

Convection mode is best suited for traditional baking and roasting and you should only use one shelf at a time, otherwise the heat distribution will be uneven. You can balance the amount of heat between the top and the bottom of the dish by selecting a different shelf height. If you want more heat at the top of the dish place the dish on the top or second shelf. For more heat at the bottom of the dish, place the dish on third or fourth shelf.

Grill mode

Select 'Grill' mode with the cooking mode selection knob and turn cooking temperature selection knob to 'Max'. When set to Grill mode, the top inner element operates. The extremely high and direct temperature of the grill makes it possible to brown the surface of meats and roasts while locking the juices in to keep them tender. Grill mode can also be used for dishes that require a high temperature on the surface such as beef steaks, veal, rib steak, filets, hamburgers, etc.

Grill food with the oven door **closed**.

Fan assisted grill mode

Select 'Fan Assisted Grill' mode with the cooking mode selection knob and turn cooking temperature selection knob between 60°C and 200°C. When set to Fan Assisted Grill mode, the top inner element and the fan operate. This mode increases the circulation of air throughout the oven, which helps prevent food from burning on the surface, allowing the heat to penetrate right into the food. Particularly suitable for kebabs made with meats and vegetables, sausages, ribs, lamb chops, chicken, quail, pork chops, fish steaks, stuffed cuttlefish etc.

In Fan Assisted Grill mode, grill with the oven door **closed**.

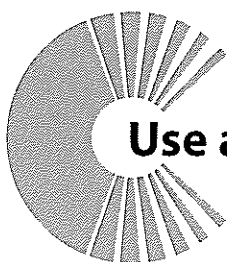

Use and Care

Delicate cooking mode

When set to Delicate cooking mode, the bottom element and the fan will operate. This mode is suitable for pastries, cakes and non-dry sweets in baking tins or moulds that require heat from the bottom.

Fan forced mode

When set to 'Fan Forced' mode, the fan element and the fan operate providing a delicate heat distributed uniformly throughout the oven.

This mode is ideal for baking and cooking delicate foods on multiple shelves, especially cakes that need to rise such as cream puffs and for certain tartlets, sweet or savoury biscuits, savoury puffs, swiss rolls and small portions of vegetables, etc.

Fast Cooking mode

When set to 'Fast Cooking' the top and bottom heating elements, as well as the fan will operate, guaranteeing constant heat distributed uniformly throughout the oven.

This mode is especially recommended for cooking prepacked food quickly (as pre-heating is not necessary), for example: frozen or pre-cooked food, as well as for a few "home-made" dishes.

The best results when cooking using the 'Fast cooking' mode are obtained if you use one rack only (the second from the bottom), please see the table entitled 'Practical Cooking Advice'.

Pizza Mode

When using Pizza mode the bottom and circle heating elements, as well as the fan will operate. This combination rapidly heats the oven due to the large amounts of power used by the appliance, which results in the production of considerable heat coming mostly from the bottom.

The pizza mode is ideal for foods requiring high temperatures to cook, like pizzas and large roasts. Only use one oven tray or rack at a time. However, if more than one is used, these must be switched halfway through the cooking process.

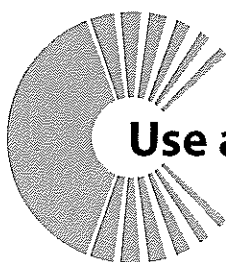

Use and Care

Multi-Cooking mode

The top, circle and bottom heating elements, as well as the fan, will come on alternately. Since the heat remains constant and uniform throughout the oven, the air cooks and browns food uniformly over its entire surface. With this mode, you can also cook various dishes at the same time, as long as their respective cooking temperatures are the same. A maximum of 2 racks can be used at the same time, following the instructions in the section entitled: 'Cooking On More Than One Rack'.

This cooking mode is particularly recommended for dishes requiring a gratin finish or for those requiring considerably prolonged cooking times, such as lasagne, pasta bakes, roast chicken and potatoes, etc... Moreover the excellent heat distribution makes it possible to use lower temperatures when cooking roasts. This results in less loss of juices, meat which is more tender and a decrease in the loss of weight for the roast. The Multi-cooking mode is especially suited for cooking fish, which can be prepared with the addition of a limited amount of condiments, thus maintaining their flavor and appearance. Excellent results can be attained when cooking vegetable-based side dishes like zucchini, eggplant, peppers, etc...

Desserts: this mode is also perfect for baking leavened cakes.

Moreover, this mode can also be used to thaw quickly white or red meat and bread by setting the temperature to 80°C. To thaw more delicate foods, set the thermostat to 60°C or use only the cold air circulation feature by setting the thermostat to 0°C.

Top heat mode

When set to Top heat mode, the top heating element operates. This mode can be used to brown food at the end of cooking.

Defrost mode

When set to 'Defrost' mode, the fan located at the back of the oven circulates room temperature air around the food. This is recommended for the defrosting of all types of food, but in particular for delicate types of food which do not require heat, for example: ice cream cakes, cream or custard desserts, fruit cakes, etc. By using 'Defrost' mode, the defrosting time is approximately halved. In the case of meat, fish and bread, it is possible to accelerate the process by selecting 'Fan Forced' mode and setting the temperature between 80°C to 100°C.

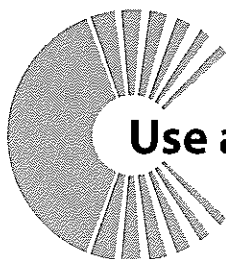

Use and Care



USING THE CONTROLS - Manual Control Knob models

Digital Clock



After pressing a function button, the required time can be set via the + or - buttons. To set the time quicker, keep the + or - buttons pressed.

By pressing the function button and then releasing it, the pre-selected function appears on the display for 5 seconds. During that time the setting can be performed. Five seconds after releasing the function button or finishing the setting, the display will return to the clock and any program set will start immediately.

Setting the time

Select the clock function by simultaneously pressing the  and  buttons. Once the clock function has been selected, the time can be adjusted by pressing the + and - buttons.

Manual operation setting

For manual operation, simultaneously press the  and the  buttons. During manual operation, a 'Saucepan' symbol will be displayed instead of the 'AUTO' symbol and any program set will be cancelled.

Semi automatic operation and cooking duration

Press the  button and set the duration by pressing the + and - buttons. During this operation, a 'Saucepan' symbol will be displayed instead of the 'AUTO' symbol. Once the set cooking time ends, the alarm will ring, the 'Saucepan' symbol will turn off and 'AUTO' symbol will blink.

Semi automatic operation and end of cooking time

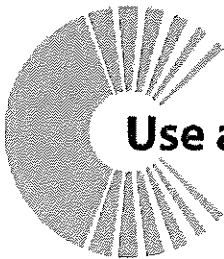

Press the  button and set the duration by pressing the + and - buttons. During this operation, both the 'Saucepan' and the 'AUTO' symbol will be displayed. Once the set cooking time ends, the alarm will ring, the 'Saucepan' symbol will turn off and 'AUTO' symbol will blink.



Use and Care



Automatic setting

Automatic setting of the oven allows you to select the end time, cooking time, temperature and cooking mode. The oven will switch on, cook according to the selected cooking mode and temperature and then switch off automatically.

1. Press  button, set cooking time with + and - buttons.
2. Press  button, set roast finish time with + and - buttons.
3. Set cooking temperature and cooking mode by turning the thermostat knob and selector knob.

After the above setting, '**AUTO**' will illuminate, which means the automatic cooking feature of the oven is set.

For example: if cooking time takes 45 minutes and you want it to finish at 14:00:

1. Press  and set the cook time to 45 minutes using + and - buttons.
2. Press  and set the finish time to 14:00 using + and - buttons.

After the above setting, the current time is displayed and '**AUTO**' will flash, indicating that the automatic cooking feature is set.

When the clock displays 13:15, the oven will start cooking automatically. While cooking, '**AUTO**' and  will flash.

When the clock displays 14:00, the oven automatically stops cooking. The alarm will ring and '**AUTO**' will flash. Press any function button to stop the ring.

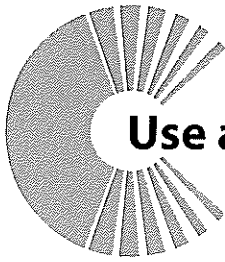

Use and Care

The oven light

Set cooking mode selection knob to  symbol to switch on the oven light/s. The oven light/s stay on when the oven is operating.

Cooling ventilation

In order to cool down the exterior of the appliance, this model is equipped with a cooling fan, which switches on automatically. When the cooling fan is on, you will notice a flow of air exiting between the oven door and the control panel.

Note: When cooking is finished, the cooling fan continues to operate until the oven cools down and then switches off automatically.

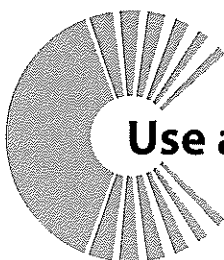



Use and Care

USING THE CONTROLS - Sensor Touch Control Panel models



Getting to know the appliance

The appliance can be operated in test mode for testing or performing all operating steps. The oven will not heat up during the test.

Switching on the test mode

1. Switch off the appliance using the On/Off  button.
2. Press and hold  and  buttons at the same time until an acoustic signal is heard and 'd' lights up in the display.





Switching off the test mode

1. Switch off the appliance using the On/Off  button.
2. Press and hold  and  buttons at the same time until an acoustic signal is heard and 'd' goes up in the display.

Setting the time

The oven only operates when the time has been set.

When the appliance is connected to the electrical supply or when there has been a power cut, the symbol for Time flashes automatically.

1. To change a time that has already been set, press the Clock functions  button repeatedly until the symbol for Time  flashes.
2. Using the  or  button, set the current time.

After about 5 seconds, the flashing stops and the clock displays the time set.



The appliance is now ready for use.

General Instructions

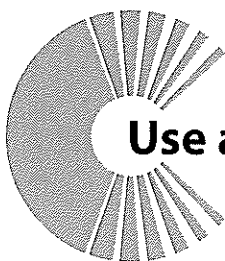

- Always switch the appliance on first by pressing the On/Off  button.
- When the selected function is lit, the oven begins to heat up or the time set begins to count down.
- The oven light is switched on as long as an oven function is started.



Use and Care

- The oven light goes off when the appliance switches off automatically.
- The oven light is switched on or gone off by pressing the  and  buttons in turn, within approx. 2 seconds when the appliance is switched off.
- Switch appliance off using the On/Off  button.



Selecting the oven function

1. Switch on the oven with the On/Off  button.
2. Press the  or  button repeatedly until the desired oven function appears.

A suggested temperature appears on the temperature display.

If the suggested temperature is not changed within approx. 5 seconds, the oven begins to heat up.

Changing the oven temperature

Press the  or  button to raise or lower the temperature.



The setting changes in steps of 5°C.

Thermometer Symbol

The slowly rising thermometer symbol  indicates how hot the oven is as it heats up.

The three segments of the thermometer symbol  show that Fast Warm Up is working.

Changing the oven function

To change the oven function, Press the  or  button repeatedly until the desired oven function is displayed.

Switching off the oven

Switch off the appliance using the On/Off  button.

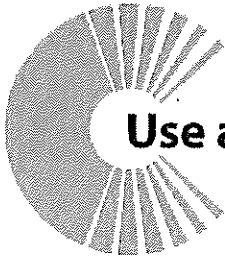

Speed Cook

After an oven function is selected, with the use of the additional function Speed cook  the empty oven can be pre-heated in a relatively short amount of time.







Use and Care

Important: Do not put the food to be cooked into the oven, **until Speed cook is completed** and the oven is operating using the desired function.



1. Set the desired function. If necessary, change the suggested temperature.
2. Press the Speed cook  button. The symbol  lights up: The bars flashing one after another showing that Speed cook is operating.
When the desired temperature is reached, the bars of the heat indicator light up. An audible signal sounds.
The oven now continues heating according to the pre-set oven function and temperature. You can now place the food in the oven.

Memory Function

The Memory function can be used to save one setting which is frequently used.

1. Set oven function, temperature and if necessary the clock functions Cook time  and/or End time .
2. Press and hold the button  for approx. 2 seconds, until an acoustic signal sounds. The setting is saved.
To replace it with another setting, press the button  for approx. 2 seconds. The previously saved setting is replaced by the new one.

Starting the Memory function

1. Switch the oven on using the button On/Off .
2. Press the button  to call up the saved setting.

Clock Functions

Cook time 

To set how long the oven is to be in use.

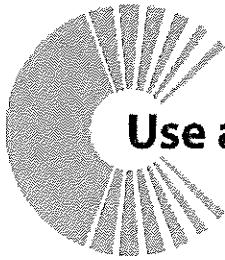

Use and Care

End Time →|

To set when the oven is to switch off.

Time ⌚

To set, change or check the time (See also section “Before Using for the First Time”)

General instructions

- After a clock function has been selected, the corresponding symbol flashes for approx. 5 seconds. During this time, the desired times can be set or modified using the **+** or **-** button.
- The time set for Cook time **|→|** and End time **→|** begins to count down after the selected function starts.

Countdown timer 🔔

The countdown timer is only available in standby mode

1. Press the clock functions **⌚** button. The bell 🔔 symbol appears.
2. Use + or – buttons to adjust the minute
3. After 5 seconds, the display will return to the current time with the bell 🔔 symbol showing
4. When the alarm sounds, it will beep 30 times. Press any button to stop the alarm.

Cook time **|→|**

1. Select oven function and using **+** or **-** button select temperature.
2. Press the Clock Functions **⌚** button repeatedly until the symbol for Cook time **|→|** flashes.
3. Using the **+** or **-** button set the desired cooking time.

The oven switches itself on. The symbol for Cook time **|→|** lights up.

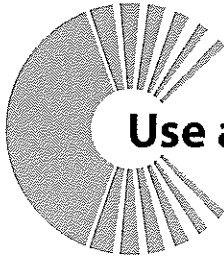







Use and Care



By repeatedly pressing the Clock Functions  button, the current time can be called up.

When the time has elapsed, an audible signal sounds 3 times.
The oven switches itself off.

“0.00” is displayed and the symbol for Cook time  flashes.
To turn off the audible signal: Press any button.

End time



1. Select oven function and using  or  button select a temperature.
2. Press the Clock Functions  button repeatedly until the symbol for End time  flashes.
3. Using the  or  button set the desired switch-off time.

The symbols for End time  and Cook time  light up.

The oven will automatically switch itself on.

By repeatedly pressing the Clock Functions  button, the current time can be called up.



When the time has elapsed, an audible signal sounds 3 times.
The oven switches itself off.



“0.00” is displayed and the symbols for End time  and Cook time  flash.

To turn off the audible signal: Press any button.

Cook time and End time combined

Can be used simultaneously, if the oven is to be switched on and off automatically at a later time.

1. Select oven function and temperature.
2. Using the Cook time  function, set the duration that the dish needs to cook, e.g. 1 hour.
3. Using the End time  function, set the time at which you would like the dish to be ready, e.g. 14:05.

The symbols for Cook time  and End time  light up.

The oven switches on automatically at the time calculated, e.g. 13:05.

When the set cooking time has elapsed, an audible signal sounds for 3 times.

The oven switches itself off, e.g. 14:05.

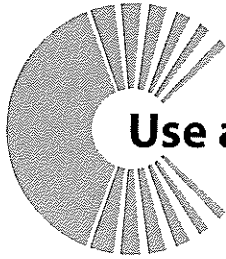



Use and Care

Other Functions



Switching off the display

You can save energy by switching off the display.

1. If required, switch off the appliance using the On/Off  button.
2. Press the Clock Functions  button and the  button at the same time until the display goes out.

As soon as the appliance is switched on again, the display comes on automatically. When the appliance is next switched off, the display goes out again.



Switching the display back on

1. If required, switch off the appliance using the On/Off  button.
2. Press the Clock Functions  button and the  button at the same time until the display comes on again.



Child Safety Device

As soon as the child safety device is engaged, the appliance can no longer be switched on.

Activating the child safety device

1. If necessary, switch on the appliance using the On/Off  button.
No oven function must be selected.
2. Press and hold the button  until  appears in the display.
The child safety device is now activated.

Deactivating the child safety device

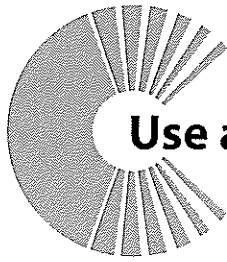

1. To deactivate, switch on the appliance using the On/Off  button.
2. Press and hold the button  until  disappears from the display. The child safety device is now deactivated and the appliance is again ready for use.



Use and Care



Button Beep

Switching off the button beep

1. Switch off the appliance using the On/Off  button.
2. Press and hold  and  buttons at the same time until a signal sounds (approx.2 seconds).

The button beep is now switched off.

Switching on the button beep

Press and hold  and  buttons at the same time until a signal sounds (approx.2 seconds).

The button beep is now switched on again.

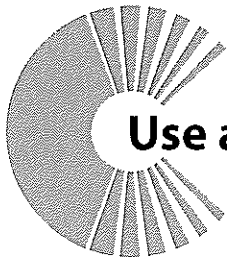

Use and Care

Rotisserie

To start the rotisserie, proceed as follows:

- Screw the plastic handle 'D' into the rotisserie rod 'A'
- Insert the rotisserie rod 'A' into the drive unit and groove 'B' into bend 'C'.
- Slide the rack into the oven runners ensuring that the rod 'E' inserts into the hole 'F'.
- The rotisserie rack must always be fitted in the middle of the oven (second position from the bottom).
- Start the rotisserie by selecting one of the following cooking settings 

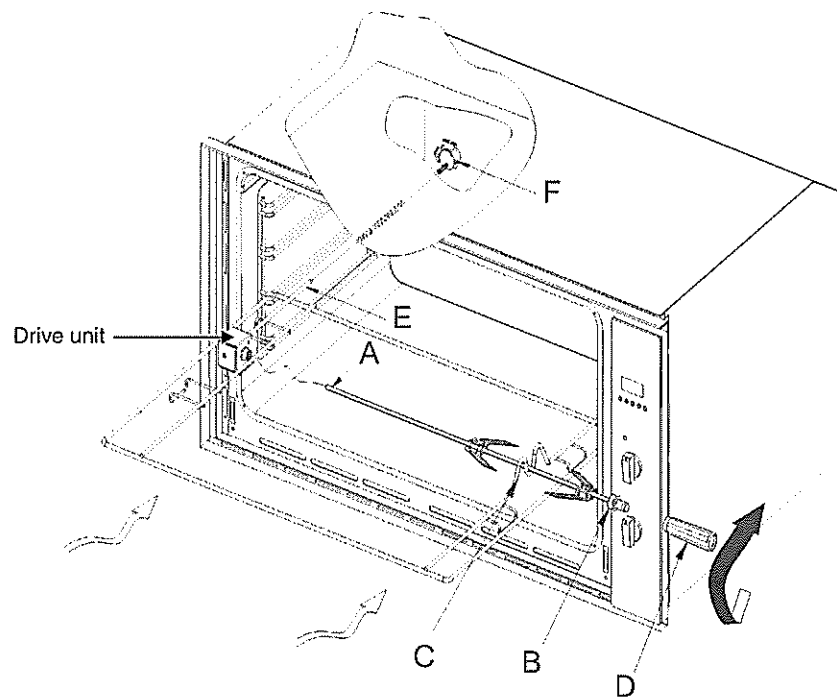

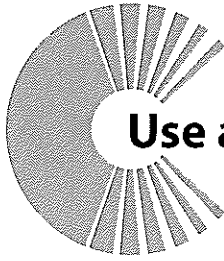



Use and Care

PRACTICAL COOKING ADVICE



The oven offers a wide range of settings which allow you to cook any type of food in the best possible way. With time you will learn to make the best use of this versatile cooking appliance and the following directions are only a guideline which may be varied according to your own personal experience.

Preheating (Manual control knob models)

If the oven needs to be preheated, the 'Convection' mode  or 'Fan Forced' mode  should be selected. These are the most efficient modes, which will reach the desired temperature as quickly as possible using the least amount of energy.

Once the food has been placed in the oven, the desired cooking mode should then be selected.

Preheating (Sensor touch models)

If the oven must be preheated (this is generally the case when cooking leavened foods), the 'Multi-Cooking' mode  and the 'Fast cooking' mode  can be used to reach the desired temperature as quickly as possible in order to save on energy.



Once the food has been placed in the oven, the most appropriate cooking mode can then be selected.

Multi shelf cooking (Manual control knob models)

If you want to cook food on several shelves, select the 'Fan Forced' mode  as this is the only cooking mode that allows you to do so.

The 'Fan Forced' mode allows you to cook delicate foods on 3 shelves at the same time. Refer to the 'Cooking Guide' table.

Multi shelf cooking (Sensor touch models)

If you have to cook food using several racks, use either the 'Fan Forced' mode  or the 'Multi-Cooking' mode , as these are the only modes that allow you to do so.

When cooking delicate food on more than one rack, use the 'baking' mode, which allows you to cook on 3 racks at the same time (the 1st 3rd and 5th from the bottom). Some examples are included in the 'Cooking Guide' table.

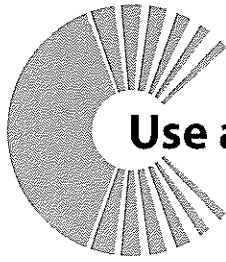

Use and Care

When cooking other food on several racks, use the 'Multi-Cooking' mode keeping the following suggestions in mind:

- The oven is fitted with 5 racks. During fan assisted cooking, use two of the three central racks; the lowest and highest racks receive the hot air directly and therefore delicate foodstuffs could be burnt on these racks.
- As a general rule, use the 2nd and 4th rack from the bottom, placing the foods that require greater heat on the 2nd rack from the bottom. For example, when cooking meat roasts together with other food, place the roast on the 2nd rack from the bottom and the more delicate food on the 4th rack from the bottom.
- When cooking foods that require differing times and temperatures, set a temperature that is somewhere between the two temperatures required, place the more delicate food on the 4th rack from the bottom and take the food requiring less time out of the oven first.
- Use the dripping pan on the lower rack and the grid on the upper.

Using the 'Fast Cooking' mode

Functional, fast and practical for those who use pre-packed products (such as: frozen or pre-cooked food) along with other food items. You will find useful suggestions in the 'Cooking Guide' table.

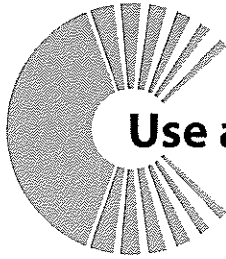

Use and Care

Using the grill

This multi-function oven has 2 different grilling modes.

Use the 'Grill' mode  with the oven door **closed**, place the food on the centre of the grill pan, insert and fit the grill pan on either the 3rd or 4th shelf from the bottom. Note: only the central part of the top heating element operates for grilling.

When using 'Grill' mode, we recommend you set the thermostat to the highest setting. However, this does not mean you cannot use lower temperatures, simply adjust the thermostat to the desired temperature.

Use 'Fan assisted grill' mode  with the oven door **closed**. This mode is very useful for grilling foods rapidly, as the distribution of heat by the fan makes it possible not only to brown the surface, but also to cook the bottom of the food. It can also be used for browning foods at the end of the cooking process, such as adding that gratin finish to pasta bakes for example.

When using 'Fan assisted grill' mode, place the food on the 2nd or 3rd oven shelf from the bottom, then place a dripping-pan on the 1st rack from the bottom to prevent fat and grease from dripping onto the oven floor. We recommend you set the thermostat to 200°C, as it is the most efficient temperature for 'Fan assisted grill' mode. However, this does not mean you cannot use lower temperatures, simply adjust the thermostat to the desired temperature.

Important: for best results and to save energy, always use the 'Fan assisted grill' with the oven door **closed**.

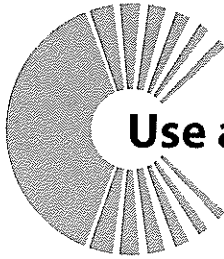

Use and Care

Baking cakes

When baking cakes, always place them in a preheated oven. Make sure you wait until the oven has been preheated thoroughly (the indicator light will turn off). To prevent heat loss and the cake from dropping, do not open the oven door during baking.

In general...

... if pastry is too dry

Increase the temperature by 10°C and reduce the cooking time.

... if pastry has dropped

Use less liquid or lower the temperature by 10°C.

... if pastry is too dark on top

Place it on a lower shelf, lower the temperature, and increase the cooking time.

... if cooked well on the inside but sticky on the outside

Use less liquid, lower the temperature, and increase the cooking time.

... if the pastry sticks to the pan

Grease the pan well and sprinkle it with a dusting of flour or use greaseproof paper.

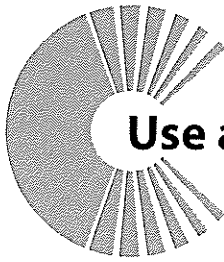

... if I used multi shelf cooking and one shelf is more cooked

Use a lower temperature setting next time. It is not necessary to remove the food from all the racks at the same time.



Use and Care

Cooking pizza

For best results when cooking pizza, use the Pizza mode . Where Pizza mode is not available as a function, use the 'Convection' mode  or 'Fan Forced' mode .

- Preheat the oven for at least 10 minutes.
- Use a light aluminum pizza pan, placing it on the shelf supplied with the oven. Don't use the dripping pan since this will extend the cooking time, making it difficult to get a crispy crust.
- Do not open the oven door frequently while the pizza is cooking;
- If the pizza has a lot of toppings (three or four), we recommend you add the mozzarella cheese on top halfway through the cooking process.
- For best results, only use one shelf at a time, but if you want to cook on two shelves, use the 2nd and 4th racks from the bottom with a temperature of 220°C and swap them halfway through cooking.

Cooking fish and meat

When cooking white meat, fowl and fish, use a temperature setting from 180°C to 200°C.

For red meat that you want well done on the outside while tender and juicy in the inside, it is best to start with a high temperature setting (200°C-220°C) for a short time, then turn the oven down afterwards.





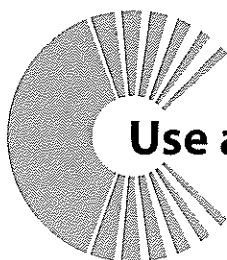

In general, the larger the roast, the lower the temperature setting. Place the meat on the centre of the shelf and place the dripping pan beneath it to catch the fat.

Make sure that the shelf is inserted so that it is in the centre of the oven. If you would like to increase the amount of heat from below, use a lower shelf height. For savoury roasts (especially duck and wild game), dress the meat with lard or bacon on the top.



Use and Care

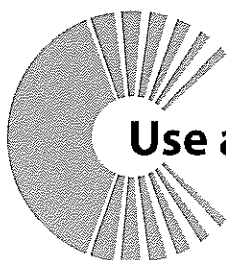

COOKING GUIDE - some functions are not available on all models

Food to be cooked	Weight (in kg)	Cooking rack position from bottom	Preheating time (Minutes)	Thermostat knob setting	Cooking time (Minutes)
 Convection					
Duck	1	3	15	200	65-75
Roast veal or beef	1	3	15	200	70-75
Pork roast	1	3	15	200	70-80
Biscuits (short pastry)	-	3	15	180	15-20
Tarts	1	3	15	180	30-35
 Top Oven					
Browning food to perfect Cooking	-	3/4	15	220	-
 Defrosting					
All frozen food					
 Grill					
Soles and cuttlefish	1	4	5	Max	8-10
Squid and prawn kebabs	1	4	5	Max	6-8
Cod filet	1	4	5	Max	10
Grilled vegetables	1	3/4	5	Max	10-15
Veal steal	1	4	5	Max	15-20
Cutlets	1	4	5	Max	15-20
Hamburgers	1	4	5	Max	7-10
Mackerels	1	4	5	Max	15-20
Toasted sandwiches	-	4	5	Max	2-3
With rotisserie (where present)					
Veal on the spit	1.0	-	5	Max	80-90
Chicken on the spit	1.5	-	5	Max	70-80
Lamb on the spit	1.0	-	5	Max	70-80
 Fan Assisted Grill					
Grilled chicken	1.5	3	5	200	55-60
Cuttlefish	1.5	3	5	200	30-35
With rotisserie (where present)					
Veal on the spit	1.5	-	5	200	70-80
Chicken on the spit	2.0	-	5	200	70-80
Chicken (on the spit)+potatoes (roasted)	1.5	-	5	200	70-75
	-	2	5	200	70-75
Lamb on the spit	1.5	-	5	200	70-80
 Multi-Cooking					
Pizza (on 2 racks)	1	2-4	15	220	15-20
Lasagna	1	3	10	200	30-35
Lamb	1	2	10	180	50-60
Roasted chicken & potatoes	1	2-4	10	180	60-75
Mackerel	1	2	10	180	30-35
Plum-cake	1	2	10	170	40-50
Cream Puffs (on 2 racks)	0.5	2-4	10	190	20-25
Biscuits (on 2 racks)	0.5	2-4	10	180	10-15
Sponge cake (on 1 rack)	0.5	2	10	170	15-20
Sponge cake (on 2 racks)	1.0	2-4	10	170	20-25
Savory pies	1.5	3	15	200	25-30



Use and Care

COOKING GUIDE - some functions are not available on all models

Food to be cooked	Weight (in kg)	Cooking rack position from bottom	Preheating time (Minutes)	Thermostat knob setting	Cooking time (Minutes)
 Baking					
Tarts	0.5	3	15	180	20-30
Fruit cakes	1	2/3	15	180	40-45
Fruitcake	0.7	3	15	180	40-50
Sponge cake	0.5	3	15	160	25-30
Stuffed pancakes (on 2 shelves)	1.2	2-4	15	200	30-35
Small cakes (on 2 shelves)	0.6	2-4	15	190	20-25
Cheese puffs (on 2 shelves)	0.4	2-4	15	210	15-20
Cream puffs (on 3 shelves)	0.7	1-3-5	15	180	20-25
Biscuits (on 3 shelves)	0.7	1-3-5	15	180	20-25
Meringues (on 3 shelves)	0.5	1-3-5	15	90	180
 Fast Cooking					
Frozen food					
Pizza	0.3	2	-	250	12
Courgette and prawn pie	0.4	2	-	200	20
Country style spinach pie	0.5	2	-	220	30-35
Turnovers	0.3	2	-	200	25
Lasagne	0.5	2	-	200	35
Golden rolls	0.4	2	-	180	25-30
Chicken morseis	0.4	2	-	220	15-20
Pre-cooked food					
Golden chicken wings	0.4	2	-	200	20-25
Fresh Food					
Biscuits (short pastry)	0.3	2	-	200	15-18
Fruitcake	0.6	2	-	180	45
Cheese puffs	0.2	2	-	210	10-12
 Pizza					
Frozen food					
Pizza	0.5	3	15	220	15-20
Roast veal or beef	1	2	10	220	25-30
Chicken	1	2/3	10	180	60-70

Note: Cooking times are approximate and may vary according to personal taste. When cooking using the grill or fan assisted grill, the dripping pan must always be placed on the 1st oven shelf from the bottom.

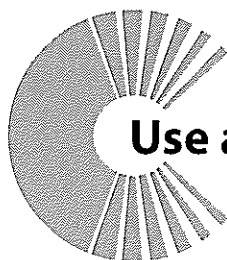

Use and Care

Cleaning and maintenance

Before cleaning your oven or performing maintenance, make sure that the cooking mode selection knob is set to '**OFF**' and the cooking temperature selection knob is set to '**OFF**'. To extend the life of your oven, it must be cleaned frequently.

The enamelled or stainless steel parts should be washed with lukewarm water without using any abrasive powders or corrosive substances. If any stainless steel has difficult to remove stains, use cleaners specifically recommended to clean stainless steel. After cleaning any surface, it is advisable to rinse thoroughly and dry.

The inside of the oven should preferably be cleaned immediately after use, when it is still warm (but not hot), with warm water and soap. The soap should be rinsed away and the interior dried thoroughly. Avoid using abrasive detergents, scourers acidic cleaners such as lime scale remover, etc. as these could damage the enamel. If stains are particularly tough to remove, use cleaners specifically recommended to clean ovens and follow the instructions provided with the cleaner. **Never use a steam cleaner or caustic oven cleaners for cleaning inside the oven.**

If you operate your oven for an extended period of time, or if you are cooking dishes that contain a lot of water, condensation may form on the oven door. Dry it using a soft cloth and try reducing the cooking temperature.

There is a rubber seal surrounding the oven opening which is necessary to ensure the correct operation of the oven. Check the condition of this seal on a regular basis. If necessary, clean it but avoid using abrasive products or objects to do so. Should it become damaged, please contact Technika Service Department. We recommend you avoid using the oven until it has been repaired.

Never place anything (including foil and oven trays) on the bottom of the oven when it is in operation because this could damage the enamel.

Clean the glass door using non-abrasive products or sponges and dry it with a soft cloth.

Use only non caustic oven cleaners purchased from hardware stores or supermarkets.

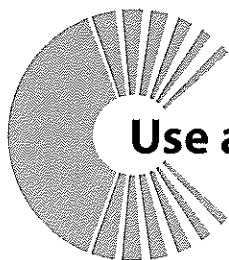

Use and Care

How to remove the oven door

You can remove the oven door for better access to the oven when cleaning. Proceed as follows to remove the door:

- Open the door fully (1).
- Lift up and turn the latch situated on each of the two hinges (2).
- Grip the door on the two external sides and close it approximately 3/4 way (3).
- Pull the door up towards you, lifting it out of the oven frame (4).
- To replace the door, use the reverse procedure.

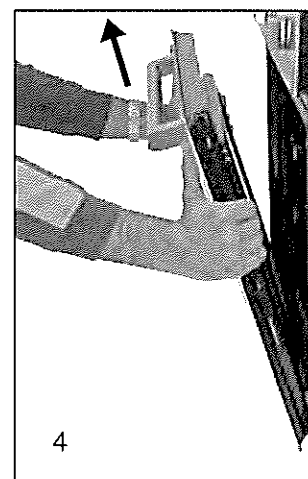
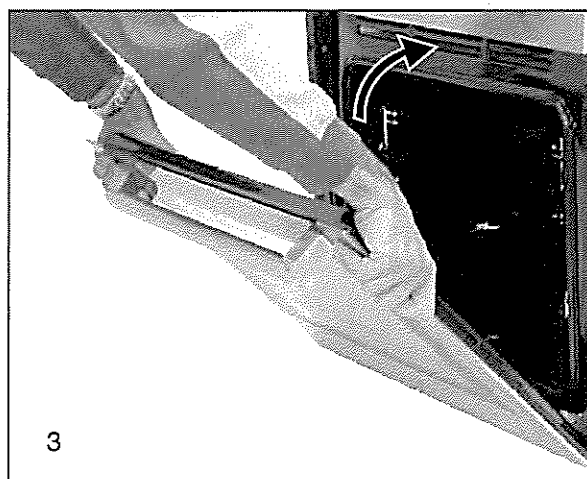
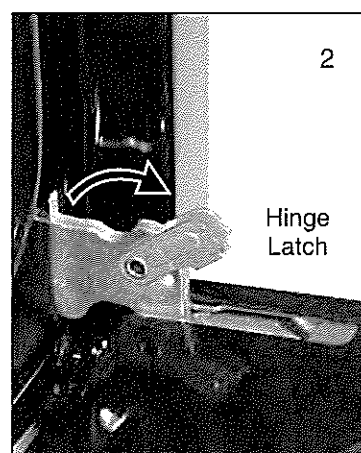
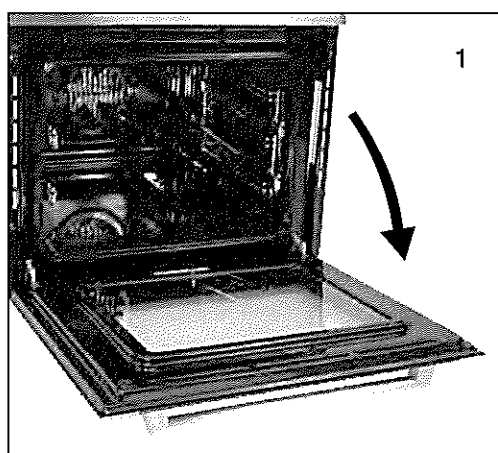

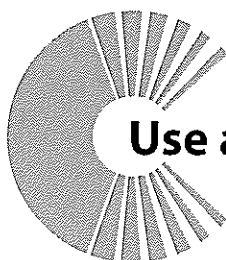

Use and Care

Replacing the Oven Lamp

WARNING: Ensure that the appliance is switched off before replacing the lamp to avoid the possibility of electric shock.

Remove the glass cover of the lamp-holder as shown below.

Remove the lamp and replace with a lamp resistant to high temperatures (300°C) with the following characteristics:

- Voltage: 220-240V
- Wattage: 25W
- Type: E 14

Replacement lamps are available from Technika. Replace the glass cover and reconnect the oven to the mains power supply.

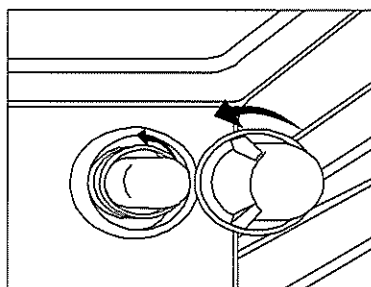

Disposal

By ensuring this product is disposed of correctly, you will help prevent potential negative consequences for the environment and human health, which could otherwise be caused by inappropriate waste handling of this product.



The symbol on the product indicates that this product may not be treated as household waste. Instead it shall be handed over to the applicable collection point for the recycling of electrical and electronic equipment.

Disposal must be carried out in accordance with local environmental regulations for waste disposal.

For more detailed information about treatment, recovery and recycling of this product, please contact your local city council office.

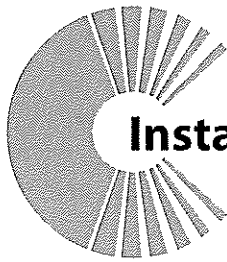

Installation

IMPORTANT: Installation, assembly and electrical connections must be carried out by authorised personnel.

Cabinet details

In order to ensure that the built-in appliance functions properly, the cabinet containing it must be appropriate. The figure below gives the dimensions of the cut-out for installation under the counter.

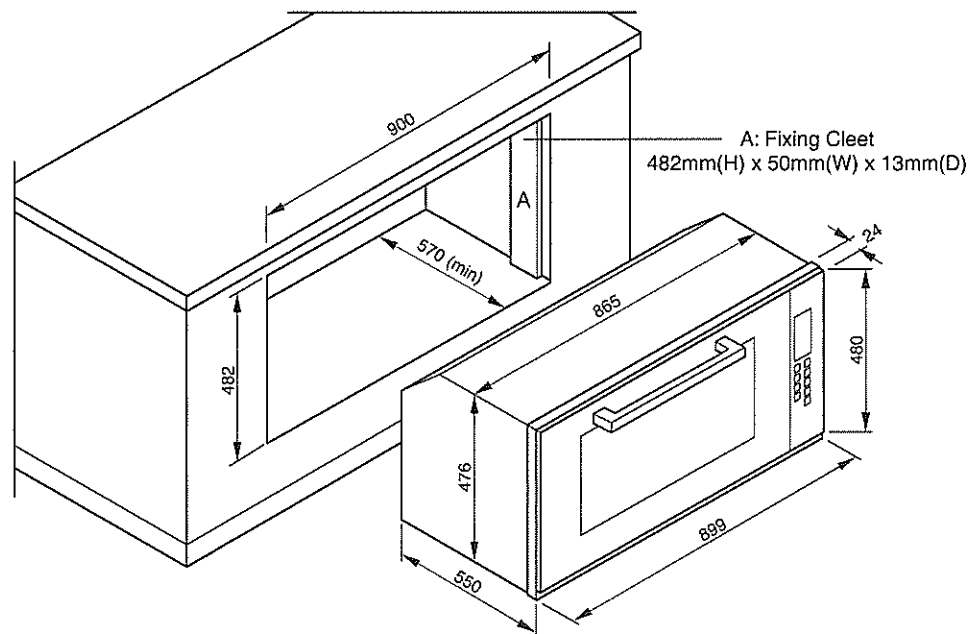

In order to ensure adequate ventilation, the back panel of the cabinet unit must be removed. The oven must have a 40mm clearance between the oven and the rear timber panel.

The panels of the adjacent cabinets must be made of heat-resistant material. In particular, cabinets with a veneer exterior must be assembled with glues which can withstand temperatures of up to 100°C.

In compliance with the current safety standards, contact with the electrical parts of the oven must not be possible once it has been installed. The oven must be secured by 4 screws to the cabinet.

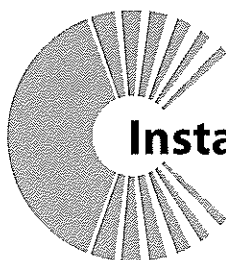

Installation

Electrical connection

The appliance is usually supplied fitted with a power cord and 3 pin plug. Install the cooker so that the plug is easily accessible. Plug the 3-pin plug into a properly earthed, 15A general purpose power outlet. The supply cable should be positioned so that it does not reach a temperature of more than 75°C along its entire length.

If the appliance is not supplied with a plug or if connecting the cable directly to the mains, connection to the electricity supply must be made by an authorised person in accordance with the Wiring Rules AS/NZS3000. The installation must include a suitable isolating switch with a minimum contact opening of 3mm between the appliance and the mains. The isolating switch should be sized according to the load on the data label and should comply with current regulations (the earth wire should not be interrupted by the circuit breaker).

Before making the connection check that:

- the switch, wiring and electrical system can support the appliance load (see data plate);
- the power supply system has an efficient earthing connection which complies with the provisions of current regulations;
- the power outlet or omnipoar circuit-breaker is easily accessible once the cooker has been installed.

Replacing the power supply lead

If the supply cord or plug is damaged, it must be replaced by the manufacturer or its service agent or a similarly qualified person in order to avoid hazard.

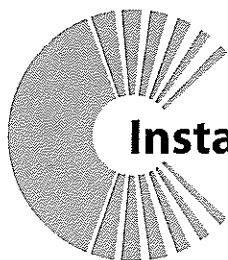

Installation

Technical data

Inner dimensions of the oven:

Width: 65.7cm

Depth: 43.5cm

Height: 35.1cm

Inner Volume of the oven: 105 litres.

Voltage and Frequency of Power Supply:

220-240V ~50/60Hz or 50Hz



TECHNIKA PTY LTD ACN 069 686 326
77 FILLO DRIVE SOMERTON VIC 3062
General : 1800 649 969 - Service : 1800 333 244
Technika After Sales Service - P.O. Box 543 SOMERTON VIC 3061

Version 2 Revision 20130903